

# WE PROVIDE SOLUTIONS.

Valcom's long tradition of communication leadership and innovation addresses our customers' most complex communication concerns. Our products are developed to fit each unique situation.

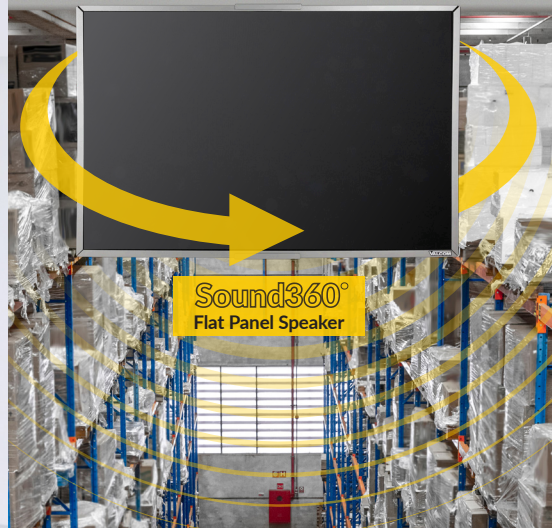





## Who we are... what we do...

Valcom, the largest provider of telephone integrated paging systems in the world, knows and understands customer needs.

Valcom's unique and extensive experience in IP and analog voice paging systems, mass notification, IP systems and telecommunication enhancements gives us a unique perspective.

Page Number

<b>New Products Spotlight</b> .....	4-6
<b>Engineered Solutions Spotlight</b> .....	7
<b>Speakers &amp; Horns</b>	
Ceiling Speakers .....	8-10
Signature Series High-Fidelity Speakers .....	11
Wall Speakers .....	12-14
Vandal-Resistant Speakers .....	15
Horns .....	16-17
<b>Paging</b>	
SIP Paging .....	18-19
Analog Paging .....	20-21
Advanced Communication Systems .....	22-23
Intercom/Door Entry .....	24
Power Supplies .....	25
<b>Accessories</b>	
Call Buttons, Volume Controls .....	26
Spot SoundMasking, Measuring Sounds .....	27
Microphones .....	28
Paging Expansion .....	29
Managing Sound, Amplifiers .....	30
Feedback, Message-On-Hold .....	31
Tones, Strobes .....	32
Interactive Console .....	33
LED Message-Sign-Speakers .....	33
Valcom SIP HelpPoints .....	34-35
<b>Clock Systems</b>	
Clocks IP PoE Clocks, Wireless, Wired .....	36-37
Clock Controls, Drivers & Accessories .....	38
IP Clock/Speaker Combos .....	39
IP Clock Speaker Kits .....	40
Clock/Speaker Assemblies .....	41-42
Easy 1-2-3 Analog Design System .....	42
Notes .....	43
<b>Index – Descriptive</b> .....	44-49
<b>Index – Numerical</b> .....	50-51



# Easy IP Design System



From the most basic Valcom IP system to tens of thousands of endpoints, Valcom provides a mix of technologies to meet customer's needs.

Valcom's full catalog of product offerings may be used in a multitude of combinations to provide an "exact fit" public address or emergency mass notification system solution.

## ACCESS

Most systems are conveniently accessed through a facility phone system. We have gateways that allow system access from session initiation protocol (SIP), FXO ports, FXS ports, paging ports, microphones or a mix of these technologies to meet the customer's needs.

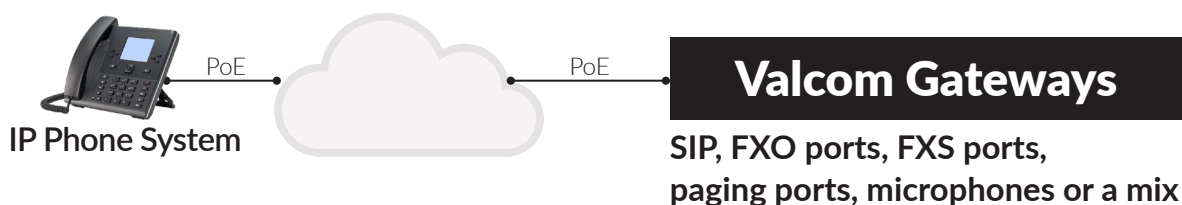



# New Products Spotlight

## Sound360° Flat Panel Speaker



### Live Voice & Background Music for Large Spaces

#### <sup>A</sup> Sound360° Flat Panel Speaker

The innovative Sound 360° Speaker, provides 360° coverage in open spaces and produces less reverberation than cone-type speakers. The Sound 360° Speaker is a flat panel style that is suitable for large areas such as warehouses and manufacturing facilities that can be used for voice paging & background music.

- 360 degree coverage in an open space
- Sound produced has less reverberation than cone style speakers
- I beam and wall mount
- Lightweight with a powder coated finish on aluminum frame

**Higher acoustical quality and a greater reach than what most traditional speakers provide, while reducing the number of speakers required**

IP One-Way ..... **VIP-2270**  
19.23in W x 13.29in H x 2.95in D (48.84cm x 33.76cm x 7.49cm)

Self-Amplified One-Way ..... **V-2271-40**

25/70 One-Way ..... **V-2273**  
29.25in W x 19.25in H x 3.00in D (74.30cm x 48.90cm x 7.62cm) 7.25lbs (3.29kg)  
Dimensions with wall bracket 4.50in D (11.43cm)



# New Products Spotlight

## Relay information rapidly!

Send live voice, pre-recorded audio, wav files and visual notifications with the touch of a button.



### B IP Interactive Console

Quickly activate emergency alerts and streamline daily communications with easy browser-based scheduling options with the Interactive Console. Users are able to receive and initiate intercom calls to IP endpoints throughout your organization as well as broadcast public address announcements. The VIP-893 is powered by PoE+ or 12 Vdc.

- IP Interactive Console ..... **VIP-893**
- IP Interactive Console with Scheduler ..... **VIP-893S**
- Scheduler Firmware Upgrade for customers with VIP-893 ... **L893-S**

### C IP Building Communication Panel

The VIP-895-S Building Communication Panel is designed around daily communication needs for organizations who need to provide one-way communication to their employees. The VIP-895-S is equipped with a **Scheduler**, so supervisors can schedule shift and break tones for your facility. VIP-895-S is focused around sending viable communications to an organizations' employees. Managers can pre-record messages, send live audio and visual notifications or upload wav files. If an emergency arises, the VIP-895-S can be used to send one-way emergency alert notifications via audio and text for LED signs.

- IP Building Communication Panel with a Scheduler ..... **VIP-895-S**



### D IP Emergency Communication Panel

The VIP-895-E Emergency Communication Panel is designed to streamline emergency notifications to your audience. The VIP-895-E can store pre-recorded emergency notifications such as evacuate, lockdown and shelter-in-place, so that you can quickly broadcast audio and visual emergency alerts throughout your facility.

For locations in California, Washington, and Oregon, the VIP-895-E is capable of **Valcom's Earthquake Early Warning System** that is compatible with the USGS' **ShakeAlert**® to instantly send earthquake early warnings.

- IP/SIP Emergency Communication Panel ..... **VIP-895-E**

Be prepared with USGS **ShakeAlert**™ capability for added safety:



### Handset for one-way paging





Best All-Around  
paging interface to  
keep in stock for  
any application!



## Analog or SIP Based Paging Adapters

The V-9972  
Universal Paging Interface  
provides access to  
virtually any paging  
system from a variety of  
phone system connections.  
Designed for quick and  
easy installation.

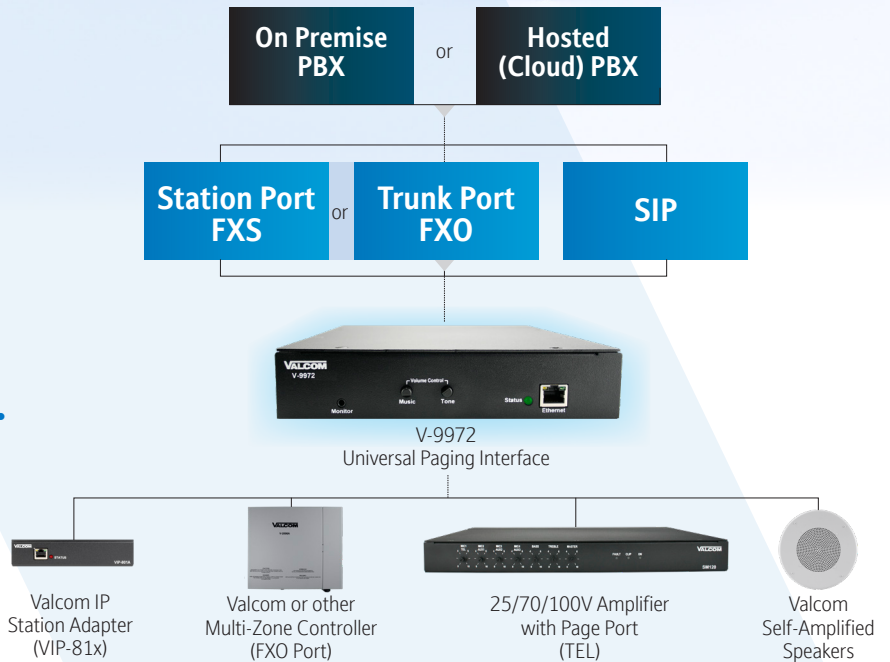

## Universal Paging Interface

Universal Paging Interface provides access to virtually any paging system from a variety of phone system connections. Designed for quick and easy installation.

Analog or SIP Based Universal Paging Interface

- Use with Valcom multi-zone page units
- Use with Valcom talkback page units
- Background music mutes during page
- Customizable pre-page alert tone
- Music and tones volume controls
- Feedback elimination
- Multiple disconnect options
- Security code option
- SIP compatible, TLS/SRTP supported for SIP
- Multiple units can be connected in tandem
- Web interface
- Requires a power supply; **VP-624D** not included, but recommended

### 1 Zone

FXS Extension, PBX Station Extension, Electronic Key Line, PBX Loop Start Trunk Port, Standard Telephone, SIP

Universal Paging Interface ..... **V-9972 -12**

Universal Paging Interface with Licenses ... **V-9972-2 -12**

9.25in W x 10.12in D x 1.72in H (23.49cm x 25.70cm x 4.36cm) 2.50lbs (1.13kg)



### Scan for License Options:

Additional features, such as multiple SIP lines and enhanced Night Ring can be added with additional license purchase.

Extended Functions  
upgrade license **L9972-1**

Gateway Functions  
upgrade license **L9972-2**

**-12 +30**  
Understanding  
VPU's  
see pg 42



## Confidently reach multiple people through multiple touch points.

We can do it all. Design the solution, provide the touch points, install the hardware and help you manage it all through our exclusive software.

We'll train your people thoroughly on all aspects of the system, even use your existing infrastructure if you want. We're flexible, adaptable and affordable. With Valcom, you always know what's going on. You're always in control.

**Ready to see what Valcom can do for you?**

**Let's Talk**

**800.825.2661**

[esd@valcom.com](mailto:esd@valcom.com)

### EMERGENCY PROTOCOL AUTOMATION

-  Hold
-  Secure
-  Lockdown
-  Evacuate
-  Shelter
-  Reunify

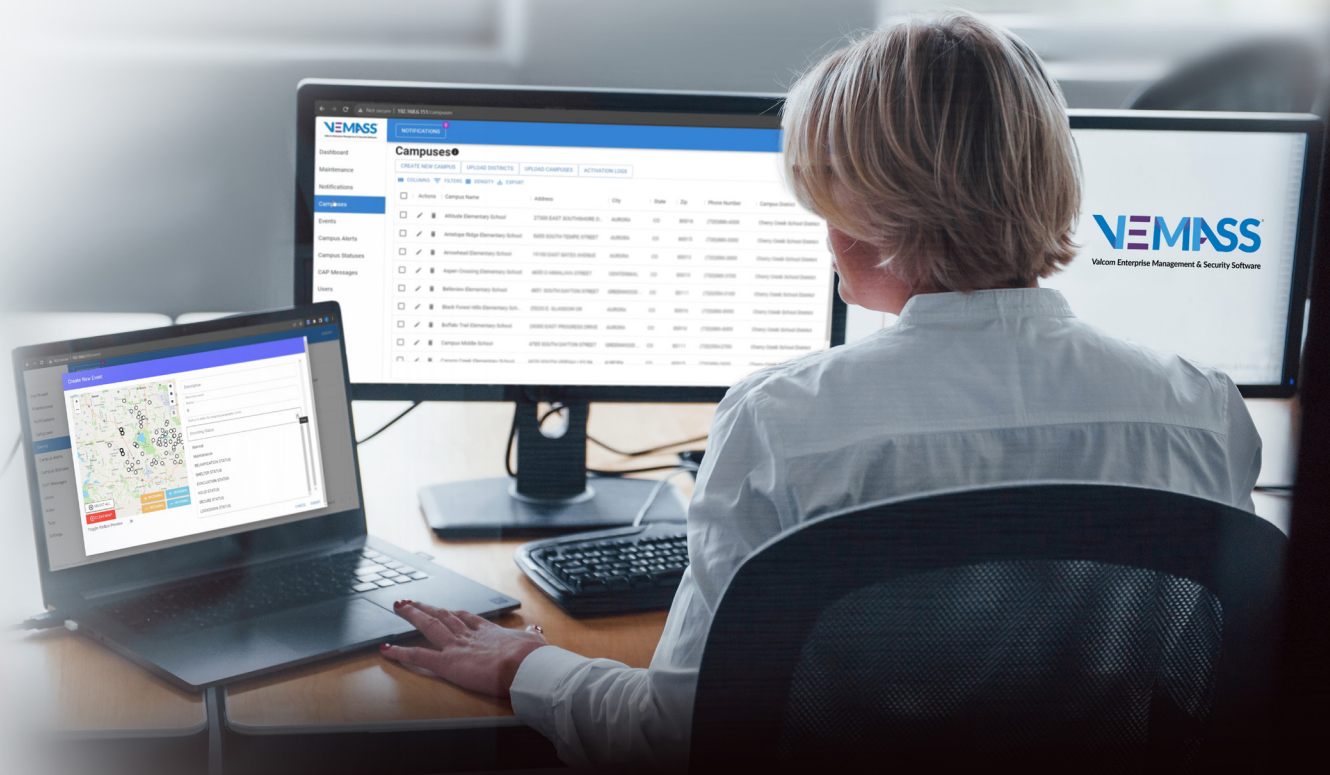



# Ceiling Speakers



**Fastest and Easiest**  
Speaker to Install!

## Lay-In Ceiling Speakers

**Easy Lay-In installation replaces a 2' x 2' tile**

Save time, effort and money — Get on and off the job quickly

No cutting tiles, no broken tiles, no mess

Lightweight — weighs slightly more than a 2' x 2' ceiling tile

Includes integral backbox that meets/exceeds  
ASTM E84 Flame & Smoke Test

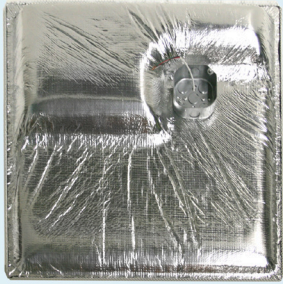

Back of A

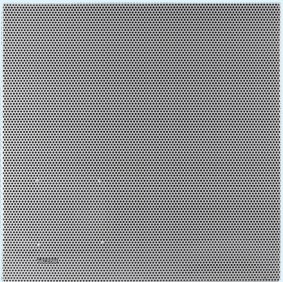

A

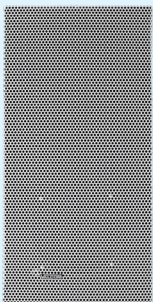

B

### A 2' x 2'

Colors: White (paintable), Custom Colors -CC

IP One-Way, SECURE	5.50lbs (2.49kg)	VIP-402A
IP One-Way, SECURE InformaCast®	5.50lbs (2.49kg)	VIP-402A-IC
IP One-Way, SECURE IntradoRevolution®	5.50lbs (2.49kg)	VIP-402A-SA
IP One-Way, SECURE European Ver. InformaCast®	5.50lbs (2.49kg)	VIP-402A-EC-IC
IP Talkback	5.50lbs (2.49kg)	VIP-422A
InformaCast®	5.50lbs (2.49kg)	VIP-422A-IC
IntradoRevolution®	5.50lbs (2.49kg)	VIP-422A-SA

One-Way (2 Pack)	13.50lbs (6.08kg)	V-9022A-2 -1
One-Way, European Version	5.80lbs (2.63kg)	V-9022-EC -1
One-Way, Dual-Input	5.80lbs (2.63kg)	V-9028 -1
Talkback	5.50lbs (2.49kg)	V-9062 0
25/70 Volt without volume control		S-422A-2
25/70 Volt with volume control		S-522B-2

U.S. Version: 23.75in L x 23.75in W x 3.75in D (60.33cm x 60.33cm x 9.53cm)  
European Version: 600mm x 600mm

### B 1' x 2'

Colors: White (Paintable), Custom Colors -CC

One-Way		V-9021 -1
25/70 Volt with volume control		S-521B
11.75in L x 23.75in W x 3.75in D (29.85cm x 60.33cm x 9.53cm)	4.70lbs (2.12kg)	

### Accessory:

Use to install in a 2' x 4' ceiling tile

Trim T-Bar (10 Pack)	V-TBAR
24.50in L x 1.25in W x 1.00in D (62.23cm x 2.54cm x 3.18cm)	3.50lbs (1.58kg)



# Ceiling Speakers

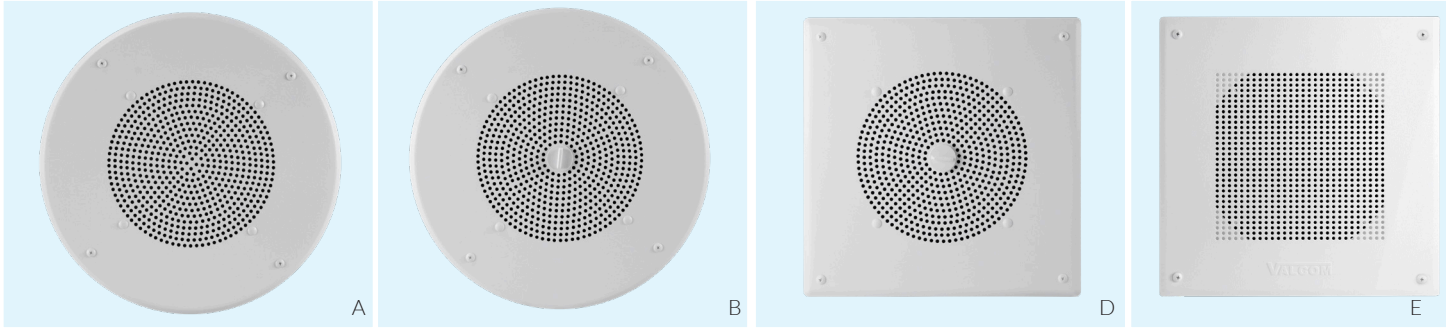

## Round Ceiling Speakers

- Exceptional voice and music reproduction
  - White epoxy finish
- Colors: white (paintable), Custom Colors -CC

### 8-Inch Round

- A **IP One-Way, SECURE** ..... **VIP-120A**  
**SECURE InformaCast®** ..... **VIP-120A-IC**  
**SECURE IntradoRevolution®** ..... **VIP-120A-SA**

- IP Talkback InformaCast®** ..... **VIP-160A**  
**InformaCast®** ..... **VIP-160A-IC**  
 13.00in Dia x 3.80in D (33.02cm x 9.70cm) 2.50lbs (1.13kg)

- B **One-Way** features: "Pop-On/Pop-Off" volume control knob  
**One-Way, SECURE** ..... **V-1020C -1**  
 13.00in Dia x 3.80in D (33.02cm x 9.70cm) 2.50lbs (1.13kg)  
**One-Way, Dual-Input** ..... **V-1220 -1**  
 13.00in Dia x 3.00in D (33.02cm x 7.62cm) 2.30lbs (1.04kg)  
**Talkback** ..... **V-1060A 0**  
**25/70 Volt** ..... **S-500**  
**25/70 Volt with volume control** ..... **S-500VC**  
 13.00in Dia x 2.50in D (33.02cm x 6.35cm) 2.50lbs (1.13kg)

- C **4-Inch Round One-Way** ..... **V-1010C -1**  
 7.65in Dia x 2.90in D  
 (19.43cm x 7.37cm)  
 1.70lbs (0.77kg)

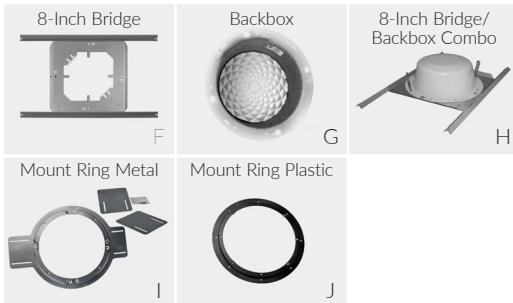
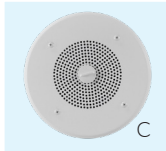

**Accessories:** Mounting Hardware M = Metal, P = Plastic

### 8-Inch Round Ceiling Speaker

- F **Speaker Bridge** (5 Pack) ..... **V-9914M-5**  
 G **Backbox** (5 Pack) ..... **V-9915M-5**  
 H **Bridge/Backbox Combo** ..... **V-9916M**  
 I **Pre-Construction Mounting Ring** (10 Pack) .. **V-9912M-10**  
 J **Post-Construction Mounting Ring** (12 Pack) ... **V-9912P-12**

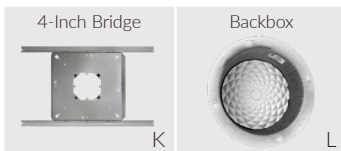

### 4-Inch Round Ceiling Speaker

- K **Speaker Bridge** (5 Pack) ..... **V-9904M-5**  
 L **Backbox** (5 Pack) ..... **V-9915M-5**  
 Use V-9904M-5 Bridge & V-9915M-5 Backbox together for a combo.

## Square Ceiling Speakers

- Exceptional voice and music reproduction
  - Wide sound dispersion
  - Electrically, acoustically matched components
  - Sturdy steel grille
- Colors: white (paintable), Custom Colors -CC

### D Square Ceiling – Round Hole Pattern

- One-Way** features: "Pop-On/Pop-Off" volume control knob  
**One-Way** ..... **V-1920C -1**  
**Talkback** 4 Volume Tap Settings ..... **V-CTSQPK 0**  
 11.50in H x 11.50in W x 3.00in D (29.21cm x 29.21cm x 7.62cm) 2.60lbs (1.18kg)

### E Square Ceiling – Square Hole Pattern

- IP One-Way or Talkback Programmable** ..... **VIP-428A**  
**InformaCast®** ..... **VIP-428A-IC**  
**IntradoRevolution®** ..... **VIP-428A-SA**  
**One-Way** ..... **V-1921 -1**  
**Talkback** ..... **V-1961 0**  
 11.50in H x 11.50in W x 4.00in D (29.21cm x 29.21cm x 10.16cm) 2.60lbs (1.81kg)

**Exceptional voice clarity reproduction**



**Accessories:** Optional Backboxes for 8-Inch Square Speakers

- M **Angled Mount** ..... **VB-A13**  
 11.54in H x 11.63in W x 4.60in D[t] x 3.15in D[b] 3.40lbs (1.53kg)  
 N **Recessed Mount** ..... **VB-R12**  
 10.75in H x 10.75in W x 3.94in D 3.00lbs (1.35kg)  
 O **Surface Mount** ..... **VB-S11**  
 11.63in H x 11.63in W x 3.94in D 3.50lbs (1.58kg)

# Ceiling Speakers



A

## Fast Installation Quick to Relocate!



D



A

### A P-Tec™ Ceiling Speaker

Easy push/lock speaker installs in tile ceilings

- Great for open offices where speaker relocation is made easier
- Side dispersion angle
- Lightweight, easy to mount and move

Color: White

**One-Way** ..... **V-1001-1**  
8.00in Dia x 2.50in H (20.32cm x 6.35cm) 0.75lbs (.34kg)



B

### B Clean Room Speaker

Designed for applications where concentration of airborne particles is controlled. For pharmaceutical, medical and other critical manufacturing environments

- Large rubber o-ring to seal the grille to the ceiling
- Rubber washers for all mounting hardware
- Polycarbonate dust shield between speaker and grille

Color: White

**IP One-Way or Talkback Programmable** ..... **VIP-140A**  
**One-Way** ..... **V-1040-1**  
13.00in Dia x 3.00in D (33.02cm x 7.62cm) 2.5lbs (1.13kg)



C

### C Surface Mount Ceiling Vandal-Resistant Speaker

Ideal for concrete ceilings and harsh areas: correctional institutions, outside entrances, industrial

- Tapered exterior, heavy-gauge steel construction
- Steel-mesh security screen prevents objects from penetrating speaker
- Tamper-resistant screws resist removal
- White epoxy finish, available in Custom Colors

Colors: White (Paintable), Custom Colors -CC

**One-Way** ..... **V-9010-W-1**  
8.50in Dia x 5.10in D (21.59cm x 12.95cm) 4.80lbs (2.18kg)

### D Pendant Speakers

Great for high ceilings

Ideal for: retail, restaurant, office, hallway, and covered patios

- High-efficiency speaker
- Metal, weather-resistant enclosure
- Simply hang from included six foot chain

Housing Colors: Black -BK, Gray -GY, White -W, Custom Colors -CC

### IP One-Way or Talkback Programmable

..... **VIP-415**

InformaCast® ..... **VIP-415-IC**

\*Talkback version of the VIP-415 does not support Call Switches

Black Grill

### One-Way

Color	Part Number
Black with Black Grille	..... <b>V-1015B-BK-6</b>
Gray with Black Grille	..... <b>V-1015B-GY-6</b>
White with Black Grille	..... <b>V-1015B-W-6</b>

**25/70 Volt** Black with Black Grille .. **S-520B-BK**  
**25/70 Volt** White with Black Grille .. **S-520B-W**

White with White Grill

### One-Way

Color	Part Number
White with White Grille	..... <b>V-1015B-WW-6</b>

5.80in Dia x 8.80in H (14.73cm x 22.35cm) 3.20lbs (1.45kg)

### Accessory:

**Additional Six Foot Chain** ..... **V-1093-BK**



# Signature Series™ High-Fidelity

A Signature Series™

## Lay-In Ceiling Speaker™

Easy Lay-In Installation Replaces a 2' x 2' Tile

- Save time, effort and money  
- Get on and off the job quickly
- No cutting tiles, no broken tiles, no mess
- Lightweight - weighs slightly more than a 2' x 2' ceiling tile
- Includes integral backbox that meets/exceeds ASTM E84 Flame & Smoke Test
- White epoxy finish

Colors: White (Paintable), Custom Colors -CC

**One-Way** ..... **V-1422** -4

23.75in L x 23.75in W x 3.75in D (60.33cm x 60.33cm x 9.53cm)  
5.50lbs (2.49kg)

### Accessory:

Use to install in a 2' x 4' ceiling tile

**Trim T-Bar** (10 Pack) ..... **V-TBAR**

24.50in L x 1.25in W x 1.00in D (62.23cm x 2.54cm x 3.18cm)  
3.50lbs (1.58kg)

**The Very Best  
In Music Quality!**



**High-Fidelity**  
Signature Series™

B Signature Series™

## Ceiling

For Premium Music Applications

- Exceptional frequency response for voice and music reproduction
- "Pop-On/Pop-Off" volume control knob
- White epoxy finish

Colors: White (Paintable), Custom Colors -CC

**One-Way** ..... **V-1420** -4

13.00in Dia x 3.00in D (33.02cm x 7.62cm)  
3.50lbs (1.59kg)

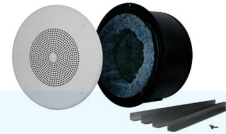

### Accessory:

**Speaker Mounting Hardware:** M=Metal  
**HiFi Bridge & Backbox** ..... **V-9816M**

C Signature Series™

## In-Wall

- Simply recess in a wall
- Paintable for a "hidden" speaker
- White epoxy finish

Colors: White (Paintable), Custom Colors -CC

**One-Way** ..... **V-1450** -4

12.00in H x 8.65in W x 3.20in D  
(30.48cm x 21.97cm x 8.13cm)  
3.00lbs (1.36kg)

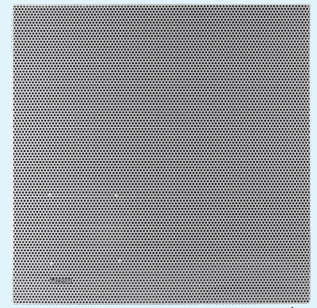

A

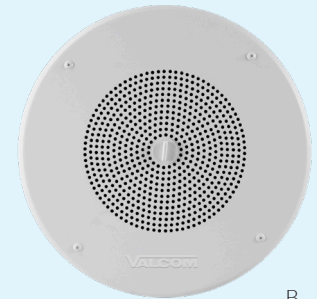

B



C

## Easy Analog Design System

### Speaker/Horn Placement Guide

Shows SPACE Between Horns & Square Foot Coverage PER Horn

Speakers	Ceiling Height x 2 = Speaker Placement Example: 8ft Ceiling x 2 = Space Speakers 16ft Apart				Horns	Quiet	Moderate	Noisy	Very Noisy
						50-65dB	65-80dB	80-90dB	90+dB
Speakers					5-Watt	110ft (12,000sq.ft)	80ft (6,400sq.ft)	50ft (2,500sq.ft)	30ft (900sq.ft)
					15-Watt	-	-	75ft (5,600sq.ft)	45ft (2,000sq.ft)
					30-Watt	-	-	-	60ft (3,600sq.ft)

Wall Speaker Placement  
Spaced 20ft Apart (One Per 600 sq. ft.)

### Power Pair Run

# Interior Speakers	Number of Speakers/Horns Per Power Run				Power Run Wire Length in Feet				
	Signature Series™	Flex Horns	5-Watt Horns	15/30-Watt Horns	24 AWG	22 AWG	20 AWG	18 AWG	16 AWG
4	1	-	-	-	1000ft	1600ft	2500ft	4000ft	6400ft
7	2	1	1	-	500ft	800ft	1280ft	2025ft	3220ft
15	4	2	2	-	250ft	400ft	640ft	1010ft	1610ft
30	8	4	4	1	125ft	200ft	320ft	500ft	805ft

# Wall Speakers

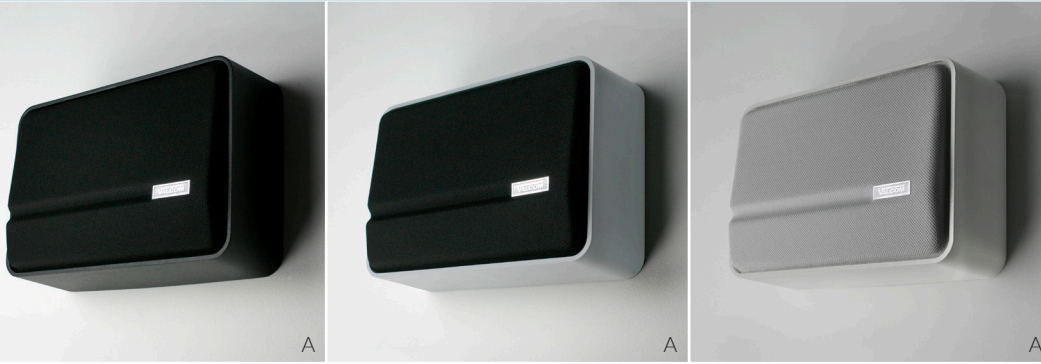

## A Slimline™ Speaker

Ideal for offices, clinics, retail, medical waiting rooms and schools

- Excellent voice & music quality . . . good looking . . . good sounding . . .
- Easy install - simply hang on a single screw or use the 2 screw bosses

Colors: Black -BK, Gray -GY, White -W

**One-Way** ..... **V-1042 -1**  
7.00in H x 10.30in W x 3.40in D (17.78cm x 26.16cm x 8.64cm) 2.80lbs (1.27kg)

### Accessory:

**Wire Guard (2 Pack)** ..... **V-WGWALL-2**  
12.00in H x 16.50in W x 5.50in D (30.50cm x 41.90cm x 14.00cm) 2.35lbs (1.10kg)

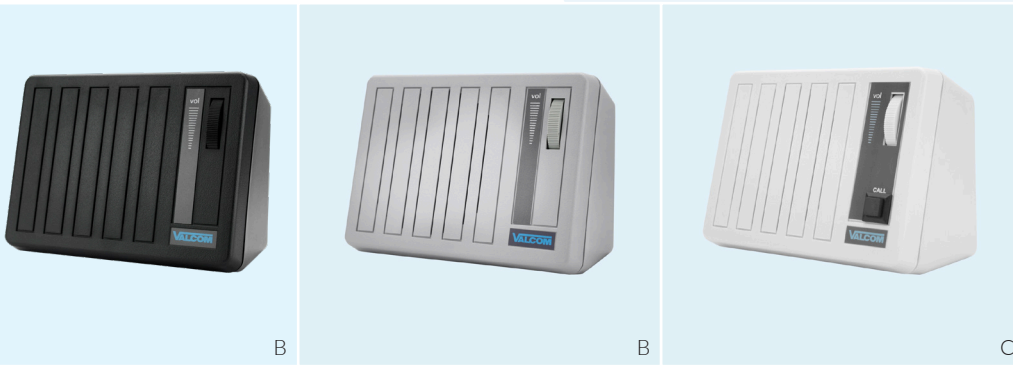
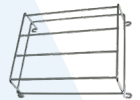

## B & C Desktop/Wall Speaker

Reach people while they're on the phone!

- Self-standing - rubber feet prevent movement on a desk surface
- Mount on a wall as a mini-speaker  
- Front cover may be rotated to match positioning on wall
- Off-hook voice announce with handsfree reply
- Volume adjusted with knob on front
- Talkback push button model available

Colors: Black -BK, Gray -GY, White -W

B **One-Way** 0.70lbs (0.32kg) ..... **V-763 -1**

**Talkback** 0.7lbs (0.32kg) ..... **V-762 0**

Colors: Black -BK, Gray -GY, White -W

C **Talkback w/Push Button** 0.7lbs (0.32kg) ..... **V-764 0**

3.90in H x 5.10in W x 3.20in D (9.91cm x 12.95cm x 8.12cm)

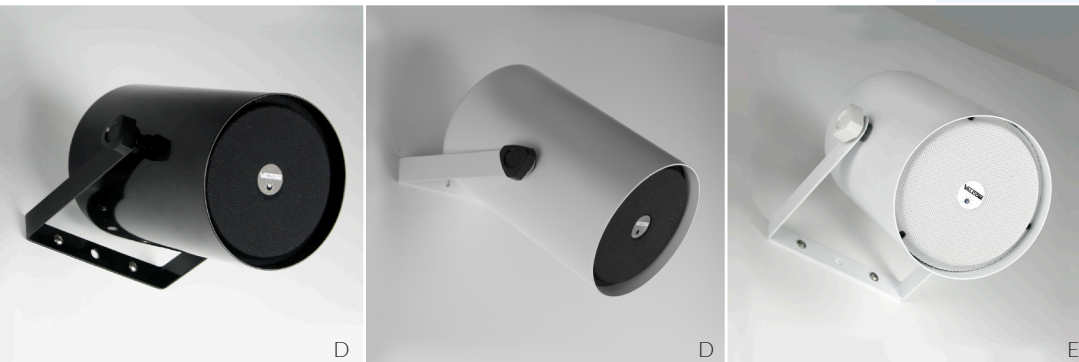

## D Track-Style Speaker

Ideal for retail, restaurants, offices, hallways and covered patios!

- High-efficiency speaker
- Metal, weather-resistant enclosure
- Attach track bracket to a wall or exposed beam
- Colors: black, white and custom colors
- Externally accessible volume control  
screwdriver adjustable through hole in grille

Colors: Black -BK, White -W and Custom Colors -CC

### 1-Watt

D **One-Way Black Grill** ..... **V-1013B -1**

E **One-Way White with White Grill** ..... **V-1013B-WW -1**  
5.80in Dia x 8.80in L (14.73cm x 22.35cm) 2.50lbs (1.13kg)

### 5-Watt

D **One-Way Black Grill** ..... **V-1014B -6**

5.80in Dia x 8.80in H (14.73cm x 22.35cm) 3.10lbs (1.41kg)



# Wall Speakers

## A Metal Wall Speaker

- Gray with black cloth grille
- Steel with a durable powder coated gray finish
- Easily match any decor by changing color of enclosure
- Easy installation - screw terminal connection
- Excellent voice and music reproduction

Colors: Gray, (Paintable), Custom Colors -CC

IP One-Way, InformaCast® ..... **VIP-410A-IC**

IP One-Way or Talkback Programmable ..... **VIP-430A**

InformaCast® ..... **VIP-430A-IC**

IntradoRevolution® ..... **VIP-430A-SA**

One-Way ..... **V-1052C** ①

Talkback ..... **V-1071** ②

25/70 Volt ..... **S-504**

10.13in H x 12.31in W x 4.63in D (25.73cm x 31.27cm x 11.75cm) 4.25lbs (1.91kg)

### Accessory:

Wire Guard (2 Pack) ..... **V-WGWALL-2**

12.00in H x 14.50in W x 5.50in D (30.50cm x 41.90cm x 14.00cm) 2.35lbs (1.10kg)

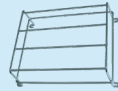

A

## B Metal Wall Corner Speaker

- Corner speaker is mounted up near ceiling to allow for easy wire connection
- 8-inch speaker
- Paintable metal housing (black cloth grille)
- Easy installation - screw terminal connection
- Excellent voice and music reproduction

Colors: Gray, (Paintable), Custom Colors -CC

Talkback ..... **V-1055** ②

10.00in H x 12.00in W x 4.50in D (25.40cm x 30.48cm x 11.43cm) 3.00lbs (1.36kg)



B

## C Square Wall Speaker

- Line output supports Valcom amplified speakers
- White paintable metal

Colors: White (Paintable), Custom Colors -CC

IP One-Way or Talkback Programmable ..... **VIP-428A**

InformaCast® ..... **VIP-428A-IC**

IntradoRevolution® ..... **VIP-428A-SA**

One-Way ..... **V-1921** ①

Talkback ..... **V-1961** ②

11.50in H x 11.50in W x 3.70in D (29.20cm x 29.20cm x 9.40cm) 4.00lbs (1.81kg)

Angled

Recessed

Surface

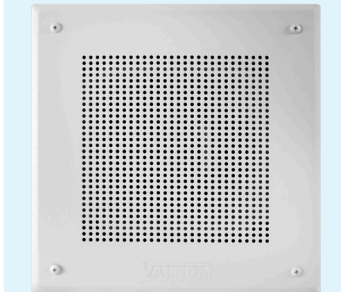

C

### Accessories: Optional Backboxes

Angled Mount ..... **VB-A13**

11.63in H x 11.63in W x 4.60in D[t] x 3.15in D[b] 3.40lbs (1.53kg)

Recessed Mount ..... **VB-R12**

10.75in H x 10.75in W x 3.94in D 3.00lbs (1.35kg)

Surface Mount ..... **VB-S11**

11.63in H x 11.63in W x 3.94in D 3.50lbs (1.58kg)

# Wall Speakers



A



B

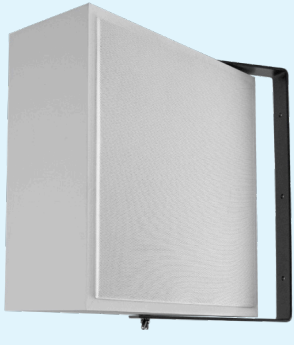

C



D



E



F

## Black & White Wall

### A Black

**One-Way** ..... **V-1016-BK -1**  
9.70in H x 11.50in W x 4.00in D (24.60cm x 29.20cm x 10.16cm) 4.10lbs (1.86kg)

**Talkback** ..... **V-1061-BK 0**  
9.60in H x 11.50in W x 4.00in D (24.38cm x 29.21cm x 10.16cm) 4.00lbs (1.81kg)

### B White

**One-Way** ..... **V-1016-W -1**  
9.70in H x 11.50in W x 4.00in D (24.60cm x 29.20cm x 10.16cm) 4.10lbs (1.86kg)

**Talkback** ..... **V-1061-W 0**  
9.60in H x 11.50in W x 4.20in D (24.38cm x 29.21cm x 10.67cm) 4.00lbs (1.81kg)

### C White Bi-Directional Corridor

**One-Way** ..... **V-1026C-W -1**  
10.30in H x 10.30in W x 4.20in D (26.16cm x 26.16cm x 10.67cm) 5.60lbs (2.52kg) CE

## Light Woodgrain Wall *Open-Weave Grille*

### D Angled Wall

**One-Way** ..... **V-1022C -1**  
9.60in H x 11.50in W x 4.00in D-Top, 3.75in D-Bottom  
(27.31cm x 24.77cm x 12.70cm-T, 9.53cm-B) 4.50lbs (2.04kg)

**One-Way, Dual-Input** ..... **V-1222 -1**  
10.75in H x 9.75in W x 5.00in D-Top, 3.75in D-Bottom  
(27.31cm x 24.77cm x 12.70cm-T, 9.53cm-B) 4.50lbs (2.03kg)

### E Bi-Directional Corridor

**One-Way** ..... **V-1026C -1**  
10.30in H x 10.30in W x 4.20in D (26.16cm x 26.16cm x 10.67cm)  
5.60lbs (2.54kg)

## Dark Woodgrain Wall *Cloth Grille*

### F Angled Wall

**One-Way** ..... **V-1023C -1**  
9.60in H x 11.50in W x 4.20in D (24.40cm x 29.20cm x 10.70cm) 4.10lbs (1.86kg)

**Talkback** ..... **V-1063A 0**

**25/70 Volt** ..... **S-505**

**25/70 Volt with volume control** ..... **S-505VC**  
9.60in H x 11.50in W x 4.20in D (24.38cm x 29.20cm x 10.61cm) 4.00lbs (1.81kg)

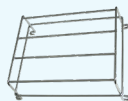

### Accessory:

**Wire Guard (2 Pack)** ..... **V-WGWALL-2**

Works with A, B, D, F

12.00in H x 16.50in W x 5.50in D (30.50cm x 41.90cm x 14.00cm) 2.35lbs (1.10kg)



# Vandal-Resistant Wall Speakers

## A Vandal-Resistant Wall Speakers

- Steel-mesh security-baffle prevents objects from penetrating the speaker
- Tamper-resistant faceplate screws resist removal
- Easy mounting to any solid surface
- Heavy-gauge steel construction (Indoor)
- 8-inch self-amplified speaker with adjustable volume
- Gray powder-coat finish, custom colors available on request  
Colors: Gray, (Paintable), Custom Colors -CC

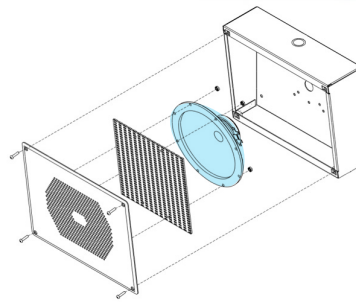

One-Way ..... **V-9852 -1**

Talkback ..... **V-9871 0**

10.00in H x 12.25in W x 4.00in D (25.40cm x 31.12cm x 10.16cm) 8.35lbs (3.80kg)



## Vandal-Resistant FlexHorns™

- Steel mesh baffle prevents objects from penetrating the speaker
- Tamper-resistant faceplate (screws resist removal)
- Mounting holes for single-gang, double-gang or octagon outlet box or attachment to any solid surface
- Heavy-gauge steel construction with gray powder coat finish, custom colors available on request (Indoor)
- FlexHorn with adjustable volume

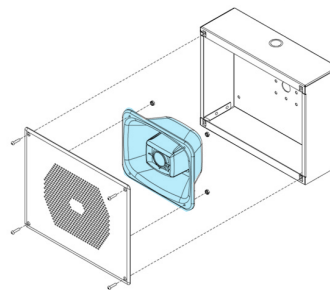

Colors: Gray, (Paintable), Custom Colors -CC

### B Surface Mount Unit

IP One-Way or Talkback Programmable ..... **VIP-580A**

InformaCast® ..... **VIP-580A-IC**

IntradoRevolution® ..... **VIP-580A-SA**

One-Way ..... **V-9880 -3**

Talkback ..... **V-9890 0**

10.00in H x 12.25in W x 4.00in D (25.40cm x 31.12cm x 10.16cm) 8.35lbs (3.80kg)

### C Angled Surface Mount Unit

IP One-Way or Talkback Programmable ..... **VIP-581A**

InformaCast® ..... **VIP-581A-IC**

IntradoRevolution® ..... **VIP-581A-SA**

9.90in H x 12.20in W x 4.00in D-Top 2.70in -Bottom (25.40cm x 30.99cm x 10.16cm)

7.40lbs (3.40kg)

### D Bi-Directional FlexHorn Surface Mount Unit

One-Way ..... **V-9885 -6**

10.00in H x 12.25in W x 7.38in D (25.40cm x 31.12cm x 18.70cm) 12.10lbs (5.50kg)

### Surface Mount Unit



B

### Angled Surface Mount Unit



C

### Bi-Directional Surface Mount Unit Great for Hallways!



D

# Horns

For industrial, manufacturing, warehouse areas

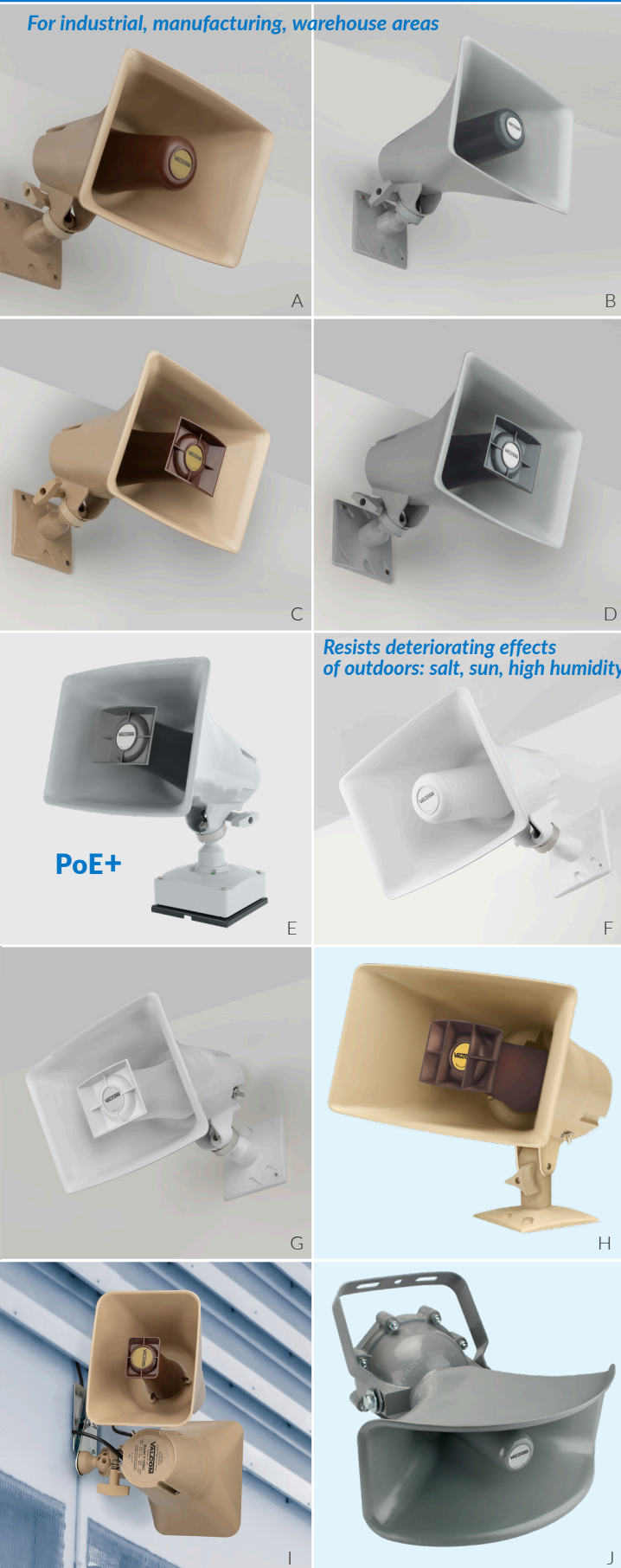

Resists deteriorating effects of outdoors: salt, sun, high humidity

PoE+

See website for dimensions and weights.

\* Long Line Extender

## High-Efficiency Horns

- Very high-efficiency ensures penetration with lower energy consumption
- Features easy Omni-Lock I-Beam clamp mounting system
- Weather-resistant – suitable for indoor or outdoor installation

A	IP One-Way <i>Beige</i> .....	VIP-130AL-BGE*
	InformaCast® <i>Beige</i> .....	VIP-130AL-BGE-IC*
	IntradoRevolution® <i>Beige</i> .....	VIP-130AL-BGE-SA*
B	IP One-Way <i>Gray</i> .....	VIP-130AL-GY*
	InformaCast® <i>Gray</i> .....	VIP-130AL-GY-IC*
	IntradoRevolution® <i>Gray</i> .....	VIP-130AL-GY-SA*
E	High Power IP Horn, Talkback <i>Gray</i> <b>PoE+</b> .....	VIP-142-GY
	InformaCast® <i>Gray</i> <b>PoE+</b> .....	VIP-142-GY-IC
	IntradoRevolution® <i>Gray</i> <b>PoE+</b> .....	VIP-142-GY-SA
A	IP Talkback <i>Beige</i> .....	VIP-148AL-BGE*
	InformaCast® <i>Beige</i> .....	VIP-148AL-BGE-IC*
	IntradoRevolution® <i>Beige</i> .....	VIP-148AL-BGE-SA*
B	IP Talkback <i>Gray</i> .....	VIP-148AL-GY*
	InformaCast® <i>Gray</i> .....	VIP-148AL-GY-IC*
	IntradoRevolution® <i>Gray</i> .....	VIP-148AL-GY-SA*
C	5-Watt One-Way <i>Beige</i> .....	V-1030C <b>-5</b>
D	5-Watt One-Way <i>Gray</i> .....	V-1030C-GY <b>-5</b>
C	15-Watt One-Way <i>Beige</i> .....	V-1036C <b>-15</b>
D	15-Watt One-Way <i>Gray</i> .....	V-1036C-GY <b>-15</b>
	15-Watt 25/70 Volt <i>Gray Metal</i> [Not Pictured] .....	S-615
A	Talkback <i>Beige</i> .....	V-1048C <b>0</b>
B	Talkback <i>Gray</i> .....	V-1048C-GY <b>0</b>
(Not Pict.)	15-Watt 25/70/100 Volt <i>Beige</i> (for Gray add -GY) .....	SX15-T
	30-Watt 25/70/100 Volt <i>Beige</i> (for Gray add -GY) .....	SX30-T

## Marine Horns

- O-ring seals
- Features easy Omni-Lock I-Beam Clamp Mounting System

F	IP One-Way <i>White</i> .....	VIP-130AL-M*
	InformaCast® <i>White</i> .....	VIP-130AL-M-IC*
	IntradoRevolution® <i>White</i> .....	VIP-130AL-M-SA*
F	IP Talkback <i>White</i> .....	VIP-148AL-M*
	InformaCast® <i>White</i> .....	VIP-148AL-M-IC*
	IntradoRevolution® <i>White</i> .....	VIP-148AL-M-SA*
G	5-Watt One-Way <i>White</i> .....	V-1030M <b>-5</b>
	15-Watt One-Way <i>White</i> .....	V-1036M <b>-15</b>
	15-Watt 25/70 Volt <i>White</i> .....	SX15-TM
	30-Watt 25/70 Volt <i>White</i> .....	SX30-TM
	Talkback <i>White</i> .....	V-1048M <b>0</b>

## H High-Noise 30-Watt Horn

For high quality voice paging, emergency alerts and loud ringing for large indoor and outdoor areas

One-Way *Beige* .....

V-1038 **Use 48VDC**

## I Bi-Directional Horns

One-Way *Beige* .....

V-1050C **-6**

## J Explosion-Proof Horn

- Includes V-1092 Volume Control
- Wide-dispersion angle
- UL Listed for use in: Class I, Groups C&D gas atmospheres

One-Way *Gray* .....

V-1039A **-20**

25/70 Volt *Gray* .....

S-660A

Accessory: Wire Guard for Horns (2 Pack) ... V-WGHORN-2

(Does not work with H, I, J)





## A Stealth Horns

- Houses a Valcom one-way FlexHorn™
  - 20-gauge aluminum powder coat paint cover
- Colors: Architectural Bronze, White -W, Custom Colors -CC

<b>IP One-Way or Talkback Programmable</b> Indoor, Bronze	<b>VIP-9831A</b>
<b>IP One-Way or Talkback Programmable</b> Indoor, White	<b>VIP-9831A-W</b>
<b>IP One-Way or Talkback Programmable</b> Indoor/Outdoor, Long Line Extender, Bronze	<b>VIP-9831AL</b>
<b>IP One-Way or Talkback Programmable</b> Indoor/Outdoor, Long Line Extender, White	<b>VIP-9831AL-W</b>
<b>One-Way</b> Indoor/Outdoor, Bronze	<b>V-9830 -③</b>
<b>One-Way</b> Indoor/Outdoor, White	<b>V-9830-W -③</b>

9.30in H x 15.00in W x 5.00in D (23.60cm x 39.10cm x 12.75cm) 7.60lbs (3.45kg)



## B Stealth Corridor Speaker

- Corridor houses a 6-inch speaker
- Colors: Architectural Bronze, White -W, Custom Colors -CC

<b>IP One-Way or Talkback Programmable</b> Indoor, Bronze	<b>VIP-9815A</b>
<b>InformaCast®</b> Indoor/Outdoor, Bronze	<b>VIP-9815A-IC</b>
<b>One-Way</b> Indoor/Outdoor, Bronze	<b>V-9815 -③</b>
<b>One-Way</b> Indoor/Outdoor, White	<b>V-9815-W -③</b>

6.75in H x 15.75in W x 6.75in D (17.10cm x 40.00cm x 17.10cm) 5.20lbs (2.35kg)

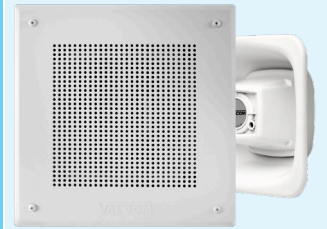

## C IP Square Surface Mount FlexHorn™

White, (Paintable), Custom Colors -CC

<b>IP One-Way or Talkback Programmable</b>	<b>VIP-9880A</b>
<b>InformaCast®</b>	<b>VIP-9880A-IC</b>
<b>IntradoRevolution®</b>	<b>VIP-9880A-SA</b>

10.75in H x 10.75in W x 4.00in D (27.31cm x 27.31cm x 10.16cm) 3.10lbs (1.41kg)

### Accessories:

<b>Backbox Recessed Mount</b>	<b>VB-R17-D</b>
-------------------------------	-----------------

9.63in H x 9.63in W x 5.94in D  
(24.46cm x 24.46cm x 15.09cm)



## D FlexHorn™

A compact design perfect for:

- Low ceilings such as light manufacturing or multi-floor warehouses
- Low to moderate noise environments
- Perfect solution for gymnasiums, prisons, subways, train stations, schools, drive-thrus, and parking garages
- Water-proof for environments requiring direct spray down such as car washes, food processing plants and operating rooms

Colors: Beige - BG, Gray -GY, White -W

<b>IP One-Way</b> Long Line Extender	<b>VIP-480AL</b>
<b>InformaCast®</b> Long Line Extender	<b>VIP-480AL-IC</b>
<b>IntradoRevolution®</b> Long Line Extender	<b>VIP-480AL-SA</b>

<b>One-Way</b>	<b>V-1080 -③</b>
<b>Talkback</b>	<b>V-1090 ①</b>

<b>70 Volt</b>	<b>S-604</b>
<b>25 Volt</b>	<b>S-604-25</b>

6.80in H x 8.30in W x 3.30in D (17.27cm x 21.08cm x 8.38cm) 2.10lbs (0.95kg)

### Mounting Options:

#### Recessed FlexHorn

The V-1080 and V-1090 can be mounted in wall.



#### Adjustable Mounting Bracket V-9804

Is Included with FlexHorn mount on wall or beam.  
5.80in H x 2.75in W x 2.05in D  
(14.73cm x 6.99cm x 5.21cm) 0.70lbs (0.32kg)



### Accessories:

<b>Wire Guard (2 Pack)</b>	<b>V-WGFLEX-2</b>
----------------------------	-------------------

13.00in H x 14.40in W x 10.50in D  
(33.00cm x 27.90cm x 25.40cm) 3.20lbs (1.50kg)

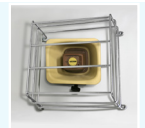

### To Make FlexHorns Vandal-Resistant: Indoor

<b>Stainless Steel, Recessed Mount Enclosure &amp; Faceplate</b>	<b>V-9805</b>
--	---------------

8.50in H x 11.00in W x 4.00in D  
(21.59cm x 27.94cm x 10.16cm) 7.50lbs (3.40kg)



<b>Stainless Steel, Recessed Mount Faceplate</b>	<b>V-9806</b>
--	---------------

8.50in H x 11.00in W x 0.13in D  
(21.59cm x 27.94cm x 0.32cm) 2.00lbs (0.91kg)



<b>Heavy-Gauge Steel, Surface Mount, Gray, Paintable Enclosure &amp; Faceplate</b>	<b>V-9809</b>
--	---------------

10.00in H x 12.25in W x 4.00in D  
(25.40cm x 31.12cm x 10.16cm) 7.00lbs (3.20kg)



# SIP Paging

## SIP connection to self-amplified speakers, IP speakers or legacy 25/70 Volt Amps

The Analog outputs on the VIP-201A and VIP-204B allow you to connect to modern self-amplified speakers or to legacy central amplified systems. The analog zones can be dialed individually or grouped. Multiple VIP-20x units can be used to give an infinite number of zones.

- Feedback elimination function
- SIP loud ringer function
- SIP night ring function
- On premise or hosted IP telephone systems



A

### A PagePro IP, SIP-Based Paging Server – 1 Zone

1 zone of one-way analog paging plus 8 zones SIP station or 100 zones SIP trunk ..... **VIP-201A**

- 1 analog audio output
- 1 AUX audio input
- 2 programmable form C relay closures



B

### B PagePro IP, SIP-Based Paging Server – 4 Zones

4 zones of one-way analog paging plus 8 zones SIP station or 100 zones SIP trunk ..... **VIP-204B**

- 4 analog audio output
- 1 AUX audio input
- 4 programmable form A relay closures

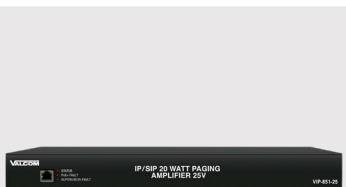
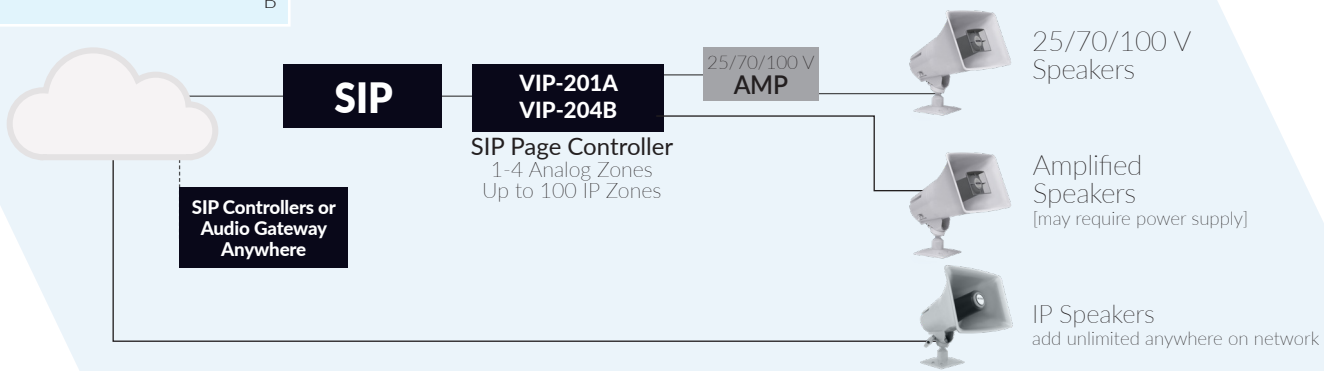

C

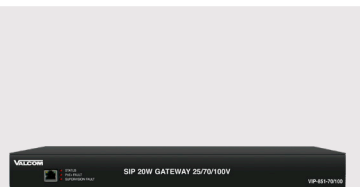

D

### C SIP 20W Gateway 25 Volt ..... **VIP-851-25 InformaCast®**

Valcom's VIP-851-25, SIP 20W Gateway 25 Volt enables voice access to a single zone of one-way paging over an IP network, allowing page zones to be extended anywhere network connectivity is available. The VIP-851-25 can be programmed as a SIP (Session Initiation Protocol) device for connectivity to virtually any VoIP (Voice over IP) telephone system. The VIP-851-25 has output connections for line level and 25-volt speakers only.

### D SIP 20W Gateway 25/70/100Volt ..... **VIP-851-70/100 InformaCast®**

Valcom's VIP-851-70/100, SIP 20W Gateway 25/70/100 Volt enables voice access to a single zone of one-way paging over an IP network, allowing page zones to be extended anywhere network connectivity is available. The VIP-851-70/100 has output connections for line level and 25-volt, 70-volt or 100-volt speakers.

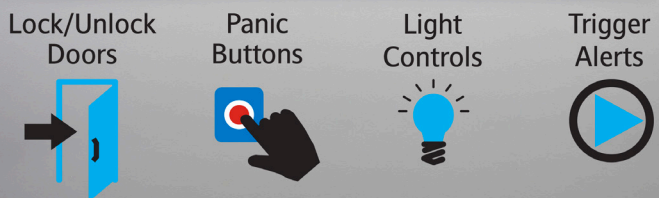

E

### E IP Network Input/Output Module ..... **VIP-848AR-IC InformaCast®**

You can easily control and monitor virtually any type 3rd party system and device with the 8 input, 8 output contact controller. Multiple devices can easily be connected and controlled via schedules or during emergencies.

- 8 relay outputs
- 8 contact closure inputs
- RJ-45 for network connection
- Front panel activity LED
- Removable terminal block connectors
- Provided for input and relay connections
- 2.5mm jack for DC power (optional)
- Power over Ethernet (PoE) 802.3af compatible



# SIP Paging

## Existing Legacy Multi-Zone Paging

- Replaces existing wired FXO connection
- Perfect for any IP telephone system
- Works with hosted IP telephone systems

The VIP-821A allows for a SIP connection to a legacy multizone intercom or paging system. This is of great benefit to customers who have moved from a traditional analog PBX to an IP telephone system. Simply take the existing FXO port connection and connect it to the line port on the VIP-821A.

Connect the VIP-821A into a PoE port on the network and register it as a 3rd party SIP extension to your IP telephone system. The customer then dials the SIP extension of the VIP-821A. The VIP-821A comes off hook and draws dial-tone from the existing intercom or paging system. No reprogramming or retraining is required.

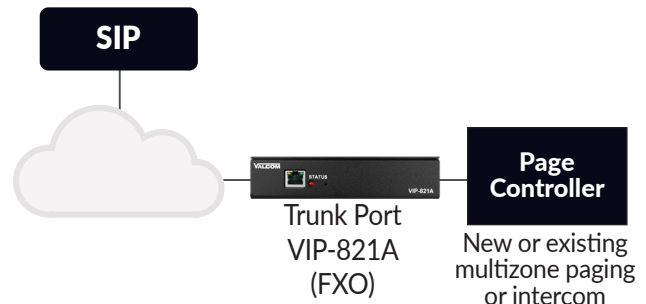

### Audio Ports (Line Level -10dbm)

Enables voice access to one-way paging over an IP-based network. This allows page zone extension anywhere on the network. It can also be programmed as a SIP device for connectivity to virtually any VoIP telephone system.

#### A 1 Audio Port

- 1 audio output and input
- 1 contact closure input
- 2 programmable form C relay contacts

1 Audio Port ..... **VIP-801A**

InformaCast® ..... **VIP-801A-IC**

IntradoRevolution® ..... **VIP-801A-SA**

#### B 2 Audio Ports

- 2 audio outputs and inputs
- 2 contact closure inputs
- 2 programmable form A relay contacts

2 Audio Ports ..... **VIP-802B**

#### C 4 Audio Ports

- 4 audio outputs and inputs
- 4 contact closure inputs
- 4 programmable form A relay contacts

4 Audio Ports ..... **VIP-804B**

### FXS Ports (Station Ports)

Valcom's IP Gateway FXS Ports enables telephones to engage in paging and phone-to-phone communications over an IP-based network.

#### D 1 FXS Port

- 1 RJ-11 FXS port
- 2 programmable form C relay contacts

1 FXS Port ..... **VIP-811A**

#### E 2 FXS Ports

- 2 RJ-11 FXS's
- 4 programmable form C relay contacts

2 FXS Ports ..... **VIP-812B**

#### F 4 FXS Ports

- 4 RJ-11 FXS's
- 4 programmable form C relay contacts

4 FXS Ports ..... **VIP-814B**

### FXO Ports (Loop Start)

Valcom's IP Gateway FXO Ports allows most loop start station ports to be connected to a managed IP-based LAN/WAN. SIP connectivity allows them to act as a gateway device between a SIP telephone system and other Valcom paging systems.

#### G 1 FXO Port

- 1 RJ-11 FXO
- 1 RJ-11 telephone failover connection

1 FXO Port ..... **VIP-821A**

#### H 2 FXO Ports

- 2 RJ-11 FXO's
- 2 RJ-11 telephone failover connections

2 FXO Ports ..... **VIP-822A**

#### I 4 FXO Ports

- 4 RJ-11 FXO's
- 4 RJ-11 telephone failover connections

4 FXO Ports ..... **VIP-824A**

See website for dimensions and weights.

# Page Controls

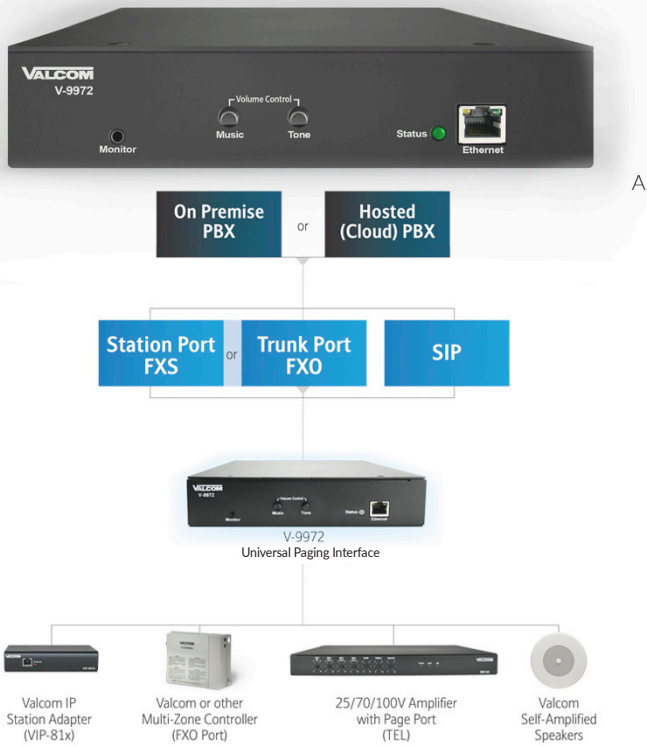

## A Universal Paging Interface

Universal Paging Interface provides access to virtually any paging system from a variety of phone system connections. Designed for quick and easy installation.

Analog or SIP Based Universal Paging Interface

- Use with Valcom multi-zone page units
- Use with Valcom talkback page units
- Background music mutes during page
- Customizable pre-page alert tone
- Music and tones volume controls
- Feedback elimination
- Multiple disconnect options
- Security code option
- SIP compatible, TLS/SRTP supported for SIP
- Multiple units can be connected in tandem
- Web interface
- Requires a power supply; **VP-624D** not included, but recommended (page 25)



**Scan for License Options:**  
Additional features, such as multiple SIP lines and enhanced Night Ring can be added with additional license purchase.

**Extended Functions**  
upgrade license **L9972-1**

**Gateway Functions**  
upgrade license **L9972-2**

### 1 Zone

FXS Extension, PBX Station Extension, Electronic Key Line, PBX Loop Start Trunk Port, Standard Telephone, SIP

**Universal Paging Interface** ..... **V-9972 -12**

**Universal Paging Interface with Licenses** ..... **V-9972-2 -12**

9.25in W x 10.12in D x 1.72in H (23.49cm x 25.70cm x 4.36cm) 2.50lbs (1.13kg)

# Analog or SIP Based Paging Adapters

## Simply Connect



**RingCentral**

## B RingCentral® Paging Adapter

**Seamlessly connects RingCentral users to their new or existing public address systems.**

Valcom's VRCPA RingCentral® Page Adapter is designed to provide access to paging systems from RingCentral hosted Session Initiation Protocol (SIP) voice over IP (VoIP) connections, or through analog trunk or station inputs (FXO/FXS).

When paired with RingCentral SIP connections the VRCPA supports Valcom handsfree page units for talkback paging and up to 150 Valcom one-way amplified speakers.

The VRCPA can connect multiple units for multi-zone paging.

SIMPLY CONNECT:

Any Legacy 25/70 Volt system

Valcom analog one-way or talkback systems

Valcom IP speaker/horn endpoints

Self-amplified speakers/horns

**RingCentral Paging Adapter** Power supply included ... **VRCPA -12**

9.25in W x 10.12in D x 1.72in H (23.49cm x 25.70cm x 4.36cm) 2.50lbs (1.13kg)





# Page Controls – Analog

**2000 Series™**  
**POWER INCLUDED**

**A 1 Zone** ◆▲ Basic zone or area of paging

The Valcom V-2000A is an integrated single zone page control unit and provides telephone access to a single zone. The V-2000A is equipped with a background music port and is voice activated music mute when it is initiated. The V-2000A drives audio up to 150 Valcom one-way self amplified speakers and has the ability to mute background music when a voice activated page is performed.

**One-Way** ..... **V-2000A +12**  
2.50in H x 7.70in W x 5.30in D (6.35cm x 19.56cm x 13.46cm) 2.60lbs (1.18kg)

**B 1 Zone Enhanced** ◆▲ Phantom Zone™ paging to all speakers/ limits music to selected speakers

Valcom's V-2001A One Zone, One-Way Enhanced Page Control Unit is an integrated page control unit equipped with a power supply to provide additional power to Valcom self-amplified speakers and horns. The built-in tone generator (single and warble) allows for night rings and break tones after normal business hours. The V-2001A enables you to do emergency page overrides for priority announcements.

**One-Way** ..... **V-2001A +20**  
**One-Way European Version\*** ..... **V-2001A-E +20**  
7.06in H x 9.00in W x 2.40in D (17.93cm x 22.86cm x 6.10cm) 3.70lbs (1.68kg)

\*European Version  
Power Requirements: 230 Vac/.5A

**C 3 Zones** ◆▲ Three zones of one-way paging plus all call

Valcom's V-2003A Page Control provides telephone system access to three zones of one-way paging and has built in tones for steady, warble and alert. The V-2003A allows you to conduct an emergency page override for priority messages. The AHF version enables you to access 3 zones for handsfree talkback capability.

**One-Way** ..... **V-2003A +20**  
7.10in H x 10.00in W x 3.00in D (18.03cm x 25.4cm x 7.62cm) 4.10lbs (1.86kg)  
**One-Way European Version\*** ..... **V-2003A-E +20**  
7.10in H x 10.00in W x 3.00in D (18.03cm x 25.4cm x 7.62cm) 4.10lbs (1.86kg)  
**Talkback** ..... **V-2003AHF +10**  
7.10in H x 10.00in W x 3.00in D (18.03cm x 25.40cm x 7.62cm) 5.60lbs (2.54kg)

\*European Version  
Power Requirements: 230 Vac/.5A

**D 6 Zones** ◆▲ Six zones of one-way paging, all call, 3 programmable zone groups

Valcom's V-2006A, 6 Zone, One-way Page Control unit that allows the user to page six individual zones of one-way paging and all call. The built-in tone generator enables you to notify with individuals through a variety of tones indicating various events such as break time. The V-2006A also has an emergency page override for priority messages so you can alert individuals of emergency or priority notifications.

**One-Way** ..... **V-2006A +30**  
10.90in H x 13.00in W x 2.70in D (27.69cm x 33.02cm x 6.86cm) 6.20lbs (2.81kg)  
**One-Way European Version\*** ..... **V-2006A-E +30**  
10.90in H x 13.00in W x 2.70in D (27.69cm x 33.02cm x 6.86cm) 6.20lbs (2.81kg)  
**Talkback** ..... **V-2006AHF +20**  
10.90in H x 13.00in W x 2.70in D (27.69cm x 33.02cm x 6.86cm) 7.50lbs (3.40kg)

\*European Version  
Power Requirements: 230 Vac/1.0A

**PBX Loop Start Trunk, Electronic Key Line, Single Line Phone**

**E 1 Zone** ◆ **Talkback** ..... **V-9941A -6**  
8.25in H x 4.65in W x 2.30in D (20.96cm x 11.81cm x 5.84cm) 1.50lbs (0.68kg)



**Station Level/FXS Adapters**  
**F 1 Zone** ● **Talkback** ..... **V-9940 -4**  
8.20in H x 4.55in W x 2.30in D (20.83cm x 11.56cm x 5.84cm) 1.70lbs (0.77kg)

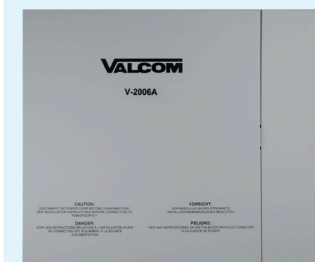
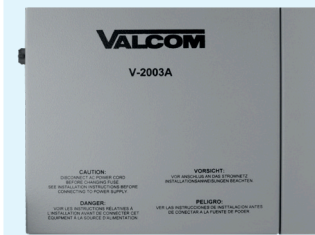
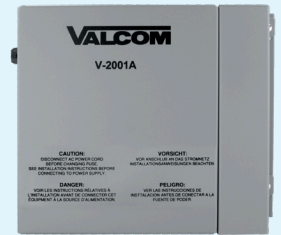

**Easy Selection Considerations**

Number of zones

One-way broadcast only

or

Talkback (includes one-way)

Two-way handsfree

Special features

Select a Page Control		One-Way Page Controls				Talkback Page Controls	
		V-2000A	V-2001A	V-2003A	V-2006A	V-2003AHF	V-2006AHF
Features	Number of Zones	1	1	3	6	3	6
	Background Music	•	•	•	•	•	•
	All Call	•	•	•	•	•	•
	Group Call				•		•
	Emergency Page Override		•	•	•	•	•
	Night Ring/Time Clock Tones		•	•	•	•	•
Valcom Power Units Provided		+ 12	+ 20	+ 20	+ 30	+ 10	+ 20
Telephone Access	<b>FXO</b> PBX Loop Start Trunk Port	•	•	•	•	•	•
	<b>FXO</b> Electronic Key Line Position	•	•	•	•	•	•
	<b>FXO</b> Dedicated Single Line Phone Set	•	•	•	•	•	•
	<b>FXO</b> PBX Ground Start Trunk Port				•		•
<b>Audio Port</b> Page Port (Telephone System Dependant)	•	•	•	•	•	•	
<b>FXS</b> Centrex or C.O. Line PBX Analog Station Port (Loop Disconnect Required)				Add V-9972		Add V-9972 or Add V-9940	

# Paging/Intercom - Analog

# ACS

by Valcom

Advanced Communication System

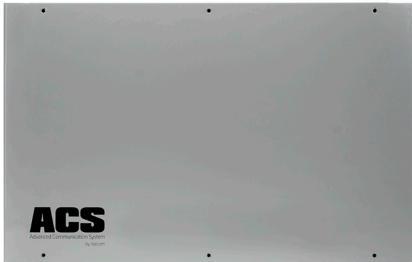

## 24 - 72 Zones

### Ideal for Schools, Institutions, Industrial, Healthcare Facilities, Airports

The ACS is a compact and scalable analog system for daily and emergency communications. The ACS is installed with Valcom's easy-to-use software that provides the user with flexibility to program multiple zones from anywhere on your network. From the comfort of your own desktop PC you have the ability to control your entire facility's daily communication and instantly alerts individuals with urgent information during an emergency, or communicate with a specific area without disturbing others.

#### FEATURES

- 24 flexible zone grouping**
- Bell schedules** — Standard calendar base
- Custom WAV file support** — Standard up to 1 hour
- Clock correction** 2-wire digital and 59th minute
- Windows-based programming & administration**
- Integrated Power**
- Talkback speaker support** — 45 Ohm or 25 Volt
- 2 Music inputs**
- 24 station zone capacity** — Expandable to 72

#### Expandable Intercom System up to 72 Zones

##### 25-Volt

25-Volt ..... **V-ACS25**

Expands the V-ACS25 to 48-Zone ..... **V-ACS-X48/25**

Expands the V-ACS25 to 72-Zone ..... **V-ACS-X72/25**

16.15in W x 10.375in H x 4.0in D (41.30 cm x 26.36 cm x 10.16 cm) 12.22lbs (5.54kg)

##### 45-Ohm

45-Ohm ..... **V-ACS45**

Expands the V-ACS45 to 48-Zone ..... **V-ACS-X48/45**

Expands the V-ACS45 to 72-Zone ..... **V-ACS-X72/45**

16.15in W x 10.375in H x 4.0in D (41.30 cm x 26.36 cm x 10.16 cm) 12.22lbs (5.54kg)

#### Accessories:

##### 24 Station Cable Adapter

for transition from V-2924A to V-ACS45 ..... **V-CA2924**

All ACS Products VPU 0



**Integrate existing or new audio systems and equipment with Valcom's VEIP6K-1 to deliver daily or emergency notifications within your organization.**

**Contact Valcom Engineered Solutions 1.800.825.2661**



# Paging/Intercom - Speakers & Accessories



## Talkback Speakers & Accessories

### A Round Ceiling Speakers

Industry recognized for exceptional performance for voice and music!

- White epoxy finish, *Custom Colors -CC*
  - Mounting hardware - See Page 9
- Colors: *White (Paintable), Custom Colors -CC*

**8-Inch Round Ceiling Speaker** Talkback..... **V-C806PK**  
13.00in Dia x 2.25in D (33.02cm x 6.35cm) 2.50lbs (1.13kg)

**8-Inch Round Ceiling Speaker** Talkback..... **VC-1060A**  
13.00in Dia x 2.25in D (33.02cm x 6.35cm) 2.50lbs (1.13kg)

### B Square Ceiling or Wall Speaker

- White epoxy finish
- Colors: *White (Paintable), Custom Colors -CC*

**8-Inch Square Ceiling Speaker** Talkback..... **V-CTSQPK**  
11.50in H x 11.50in W x 3.00in D (29.21cm x 29.21cm x 7.62cm) 2.60lbs (1.18kg)

### C Lay-In Ceiling Speakers™ w/Backbox

*Easy Lay-In installation replaces a 2' x 2' tile*

- Lightweight - Weighs slightly more than a 2' x 2' ceiling tile!
- Save time, effort and money - Get on and off the job quickly
- No cutting tiles, no broken tiles, no mess
- Excellent music and voice quality
- Durable white acrylic baked enamel finish, *Custom Colors -CC*
- Integral backbox meets or exceeds ASTM E84 Flame & Smoke Test

Colors: *White (Paintable), Custom Colors -CC*  
**2' x 2' Lay-In Ceiling Speaker** Talkback..... **VC-9062**  
23.75in L x 23.75in W x 3.75in D (60.33cm x 60.33cm x 9.53cm) 8.3lbs (3.74kg)

**2' x 2' Lay-In Ceiling Speaker** Talkback (2 Pack)..... **V-CTLA-2**  
23.75in L x 23.75in W x 3.75in D (60.33cm x 60.33cm x 9.53cm) 8.5lbs (3.83kg);  
For 2 Pack: 14lbs (6.3kg)

**Optional Trim Bar** Use to Install in a 2 x 4 Ceiling Tile (10 Pack)..... **V-TBAR**  
24.50in L x 1.25in W x 1.00in D (62.23cm x 2.54cm x 3.18cm) 3.50lbs (1.58kg)

### D Metal Wall Speaker

- 8-Inch speaker, excellent voice and music quality
- Easy installation, screw terminal connections
- Black cloth grille, gray paintable metal housing

Colors: *Gray (Paintable), Custom Colors -CC*  
**Metal Wall Speaker** Talkback..... **V-WTGY**  
10.13in H x 12.31in W x 4.63in D (25.73cm x 31.27cm x 11.75cm) 4.25lbs (1.91kg)

### E Black or White Wall Speakers

- 8-Inch speaker, excellent voice and music quality
- Easy installation
- Black or white simulated woodgrain

**Black Wall Speaker** Talkback..... **VC-1061-BK**  
**White Wall Speaker** Talkback..... **VC-1061-W**  
9.60in H x 11.50in W x 4.00in D (24.38cm x 29.21cm x 10.16cm) 4.00lbs (1.81kg)

### F Woodgrain Wall Speaker

- 8-Inch speaker, excellent voice and music quality
- Easy installation
- Light brown woodgrain, open-weave grille

**Woodgrain Wall Speaker** Talkback..... **VC-1062A**  
9.60in H x 11.50in W x 4.00in D-Top, 3.75in D-Bottom  
(27.31cm x 24.77cm x 12.70cm-T, 9.53cm-B) 4.50lbs (2.04kg)

### G FlexHorn™ – Rugged Speaker

- Low ceilings such as light manufacturing or multi-floor warehouses
- Low to moderate noise environments
- Water-proof for environments requiring direct spray down such as car washes, food processing plants, and operating rooms
- Adjustable Mounting Bracket included (V-9804)  
Mount on Wall, Ceiling or Beam

Colors: *Beige-BGE, Gray-GY, or White-W*  
**FlexHorn** Talkback..... **VC-1090**  
10.00in H x 12.25in W x 4.00in D (25.40cm x 31.12cm x 10.16cm) 8.35lbs (3.80kg)

## Accessories (Not Pictured)

**One-Way Paging Adapter**..... **V-LPT**

**Clock Control Interface Package**..... **V-CLK**

### Option Cards

**Large LED Display Package**..... **V-DSP**

**Serial/Clock Driver Card**..... **V-SER**

**Clock Relay Card**..... **V-CIO**

### Backplane Cables

**Cable – 4 Position Feature Cards**..... **VC40R-4**

**Cable/Terminator – 8 Position Feature Cards**..... **VC40R-8T**

**Cable/Terminator – 9 Position Feature Cards**..... **VC40R-9T**

**Cable/Terminator – 16 Position Feature Cards**..... **VC40R-16T**

### Call-In Button

**Emergency/Normal – Stainless Steel**..... **V-2970**

**Rocker Push Button – Stainless Steel**..... **V-2972**

**Rocker Push Button – Stainless Steel (6 Pack)**..... **V-2972PK**

### Power Supply

**6 Amp Positive 24 Vdc – Wall Mount**..... **V-C6124P**

See website for dimensions and weights.

All Products VPU

# SIP Intercom Door Entry



## SIP Intercom

This interior IP intercom can be easily installed in a variety of environments such as assisted living facilities, correctional facilities, business offices, school classrooms and more. Communicate with or without a SIP PBX.

- SIP compliant and Valcom Gateway accessible
- Peer-to-Peer capable
- PoE 802.3af enabled (Power-over-Ethernet)
- Fully network configurable
- Uses a standard electrical junction box enclosure
- High loudspeaker levels for use in moderate to high noise areas
- Paging speaker feature
- Mic and speaker volume control
- Stainless steel
- LED call status
- Multicast
- Enhanced tamper-resistance
- Optional: FXS or FXO access

- A **SIP Intercom Doorplate Speaker, Vandal-Resistant** ..... **VIP-176A**  
**InformaCast®** ..... **VIP-176A-IC**  
 4.88in H x 4.88in W x 2.50in D (12.40cm x 12.40cm x 6.40cm) 0.75lbs (0.34kg)
- B **Smart Relay** option for SIP Door Strikes & Gate Openers ..... **VM-SRLY**

## SIP Intercom with Long Line Extender (LLE)



- Long line situations such as elevators, etc.
- Use with Cisco, Nortel, Avaya, and most modern IP telephone systems
- Automatic talkback VOX operation (No Push to Talk Button Needed)
- Companion to IP CCTV cameras
- SIP or Multicast communications
- AllCall 1000's of units with Valcom Gateway
- LED status indicator
- Indoor/Outdoor and tamper-resistant
- Compatible with secure networks
- Supervision with alert functions
- DHCP addressable
- High survivability - No server needed
- Built-in access control relay

- C **Vandal-Resistant Stainless Steel Talkback w/LED** ..... **VIP-172AL-VRSS\***  
**Talkback w/LED, InformaCast®** ..... **VIP-172AL-VRSS-IC\***  
**Talkback w/LED, Intrado Revolution®** ..... **VIP-172AL-VRSS-SA\***  
 4.50in H x 4.50in W x 1.75in D (11.43cm x 11.43cm x 4.45cm) 1.68lbs (0.76kg)
- D **Talkback w/LED Stainless Steel** ..... **VIP-172AL-ST\***  
**Talkback w/LED, InformaCast®** ..... **VIP-172AL-ST-IC\***  
 4.50in H x 4.50in W x 1.30in D (11.43cm x 11.43cm x 3.30cm) 0.50lbs (0.23kg)  
 \* Long Line Extender

## Analog Intercom Doorplate Speakers

- Indoor/Outdoor
- Talkback speaker
- Call button
- Mounts in standard double gang electric box
- 11 gauge steel, *White paintable faceplate*
- 16 gauge steel, *Stainless Steel faceplate*

- E **Vandal-Resistant Talkback White** ..... **V-1073 0**  
 4.50in H x 4.50in W x 1.75in D (11.43cm x 11.43cm x 4.45cm) 1.50lbs (0.63kg)
- F **Talkback Stainless Steel** ..... **V-1072A-ST 0**  
**Talkback with LED Stainless Steel** ..... **V-1072B-ST 0**  
 4.50in H x 4.50in W x 1.30in D (11.43cm x 11.43cm x 3.30cm) 0.50lbs (0.23kg)
- G **Surface Mount Talkback Gray, Plastic** ..... **V-1074 0**  
 5.50in H x 4.00in W x 1.13in D (13.97cm x 10.16cm x 2.87cm) 0.50lbs (0.23kg)

**Accessory: Doorbox Weather Guard** for Intercom Doorplate Speakers (except G)

- H **Black** ..... **V-9910-BK**  
 5.25in W X 5.38in H X 3.00in D (13.34cm X 13.67cm X 7.62cm) 1.25lbs (0.56kg)
- I **Yellow** ..... **V-9910-YEL**

## Analog Door Answering/Unlock Devices

### Answer & Door Unlock Capability

- J **Single Door** ..... **V-2901A -12**
- Door unlock contact closure (strikeplate required)
  - Alarm functions
  - Transmit and receive volume controls
  - Background music input with volume control
  - Built-in ring generator with On/Off switch
  - 3 distinctive ring patterns
  - Programmable options include:
    - Door unlock codes
    - # of ring cycles before door request is terminated
    - Time the door remains unlocked
  - Requires -24 Vdc, 600mA (filtered)
- 8.60in H x 11.00in W x 2.30in D (21.84cm x 27.94cm x 5.84cm)  
 3.00lbs (1.36kg)

- K **Four Door** ..... **V-2904 -12**  
 All the functions of the single door plus:
  - Places simultaneous calls in queue
 8.60in H x 11.00in W x 2.30in D (21.84cm x 27.94cm x 5.84cm)  
 3.10lbs (1.41kg)

### L **Answering Control** Does Not Provide Door Unlock Capability

- Single Door** ..... **V-2900 0**
- Ring generator
  - Built-in talkback amplifier
  - Transmit and receive volume control
  - Provides two-way communication
  - Power supply included (VP-324D)
- 8.25in H x 4.50in W x 2.35in D (20.96cm x 11.43cm x 5.97cm)  
 3.10lbs (1.41kg)

Push a button for two-way connection

Identify visitors and unlock doors



# Power Supplies

## Power Supplies with Long Life Capacity!

- Smaller footprint — Less energy/less heat
- Barrel to wire connection
- Wall, rack/rail mount, mounting bracket included

A	<b>300 mA/24 V</b> .....	<b>VP-324D</b> +6
	2.48in H x 1.73in W x 1.08in D (7.21cm x 4.40cm x 2.74cm) 0.20lbs (0.09kg)	
B	<b>600 mA/24 V</b> .....	<b>VP-624D</b> +12
	1.42in H x 1.50in W x 3.58in L (3.60cm x 3.80cm x 9.10cm) 0.36lbs (0.17kg)	
C	<b>1 Amp/24 V</b> .....	<b>VP-1124D</b> +20
	1.22in H x 1.65in W x 4.11in L (3.10cm x 4.60cm x 9.90cm) 0.40lbs (0.20kg)	
D	<b>2 Amp/24 V</b> .....	<b>VP-2124D</b> +40
	1.38in H x 1.93in W x 4.45in L (3.70cm x 2.35cm x 12.10cm) 0.60lbs (0.30kg)	
E	<b>2 Amp/48 V</b> For V-1038, 30-Watt Horn, page 16.....	<b>VP-2148D</b> N/A
	1.50in H x 2.60in W x 6.61in L (3.90cm x 6.60cm x 16.80cm) 1.10lbs (0.50kg)	
F	<b>4 Amp/24 V</b> .....	<b>VP-4124D</b> +80
	1.57in H x 2.56in W x 7.05in L (3.60cm x 6.70cm x 16.90cm) 1.15lbs (0.52kg)	

Digital

Switching Digital

G	<b>6 Amp/24 V</b> Negative output with common positive.....	<b>VP-6124</b> +120
	10.30in H x 5.92in W x 2.50in D (26.16cm x 15.04cm x 9.53cm) 5.00lbs (2.27kg)	
	<b>6 Amp/24 V</b> Positive output with common negative.....	<b>VP-6124-P</b> +120
	10.30in H x 5.92in W x 2.50in D (26.16cm x 15.04cm x 9.53cm) 5.00lbs (2.27kg)	
Not Pict.	<b>Power Supply Shelf</b> .....	<b>VP-9202</b> N/A
	Holds two VP-6124 power supplies in a standard 19-inch rack 12.50in H x 19.00in W x 3.75in D (31.75cm x 48.26cm x 9.53cm) 5.40lbs (2.30kg)	
H	<b>12 Amp/24 V</b> .....	<b>VP-12124</b> +240
	12.10in H x 8.70in W x 3.90in D (30.70cm x 22.10cm x 9.90cm) 7.70lbs (3.50kg)	

Back-Up Power

I	<b>Battery Back-Up Power</b> .....	<b>VPB-260</b> N/A
	<ul style="list-style-type: none"> <li>• Contains long life maintenance-free gel cell batteries</li> <li>• Fuse-protected AC input, current limiting on output</li> </ul> 9.25in H x 7.50in W x 5.25in D (23.50cm x 19.00cm x 13.30cm) 19.00lbs (8.60kg)	
J	<b>Battery Back-Up Charger</b> .....	<b>VP-6124-UPS</b> 0
	<ul style="list-style-type: none"> <li>• Permits system operation in event of AC power failure</li> <li>• For use with VP-6124 Power Supply/VBB-1424</li> </ul> 10.30in H x 3.50in W x 2.25in D (26.16cm x 8.89cm x 5.72cm) 2.90lbs (1.32kg)	
K	<b>Battery Box with Batteries</b> .....	<b>VBB-1424</b> 0
	<ul style="list-style-type: none"> <li>• Complete your UPS system with battery support</li> <li>• For use with VP-6124 / VP-6124-UPS</li> </ul> 5.52in H x 8.03in W x 10.82in D (14.02cm x 20.40cm x 27.48cm) 17.50lbs (7.88kg)	

Special Purpose

L	<b>400 mA/12 V Unfiltered</b> .....	<b>VP-412A</b> N/A
	2.60in H x 2.00in W x 2.30in D (6.60cm x 5.08cm x 5.84cm) 0.70lbs (0.32kg)	
	<b>IP Local Power Option for VoIP Products</b>	
	Receptacle Mount	
M	<b>IP 24 Vdc, 300 mA</b> .....	<b>VIP-324D</b>
	2.84in H x 1.73in W x 1.08in D (7.21cm x 4.39cm x 2.74cm) 0.20lbs (0.09kg)	



## Valcom Power Units VPU's — Make it easy!

The amount of power required for a paging system is based on the quantity and type of page control and speakers/horns selected.

Valcom Products are Assigned Valcom Power Units (VPU)

Products Either Provide+ #  
or Consume- # Power

### Simply Total All:

- a. Page Control VPU's
- b. Speaker/Horn VPU's
- c. Subtract b. from a.

### Example:

Page Control 1 x +30 = + 30 VPU Provided  
Speakers 15 x -1 = - 15 VPU Consumed  
= + 15 VPU's LEFT OVER  
NO Additional Power Supply needed!

- Products that neither consume NOR provide power are a 0
- Note: one Valcom Power Unit = 50 mA., -24 Vdc
- VPU listings are on the product pages & index
- Have VPU's left over - You can add more speakers!
- Need more - Simply select a Power Supply with enough VPU's to make up the difference!



A



B



C



D



E



F



G

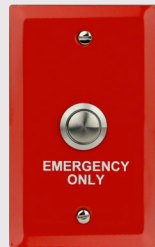

H



I



J



K



L

## Call Buttons

Provides Remote Call-In Capability

- Fits a Single Gang Box

### With Volume Control

- A **Normal Stainless Steel** ..... **V-2971** ①  
4.50in H x 2.75in W x 1.0in D (11.43cm x 6.99cm x 2.54cm) 0.20lbs (0.09kg)
- B **Normal White**..... **V-2991-W** ①  
4.50in H x 2.75in W x 0.75in D (11.43cm x 6.99cm x 1.91cm) 0.20lbs (0.09kg)
- C **Emergency/Normal Stainless Steel** ..... **V-2970** ①  
4.50in H x 2.75in W x 1.00in D (11.43cm x 6.99cm x 2.54cm) 0.20lbs (0.09kg)
- D **Emergency/Normal White**..... **V-2995-W** ①  
4.50in H x 2.75in W x 1.00in D (11.43cm x 6.99cm x 2.54cm) 0.20lbs (0.09kg)
- E **with Privacy Switch Stainless Steel** ..... **V-9320** ①  
4.50in H x 2.75in W x 1.00in D (11.43cm x 6.99cm x 2.54cm) 0.20lbs (0.09kg)
- F **with Braille Stainless Steel**..... **V-2977** ①  
4.50in H x 2.75in W x 1.0in D (11.43cm x 6.99cm x 2.54cm) 0.20lbs (0.09kg)

### Without Volume Control

- G **Rocker Push Button Stainless Steel** ..... **V-2972** ①  
**6 Pack: 1.10lbs (0.50kg)**..... **V-2972PK** ①  
4.50in H x 2.75in W x 1.5in D (11.43cm x 6.99cm x 3.91cm) 0.20lbs (0.09kg)
- H **Emergency Vandal-Resistant, Red** ..... **V-2976** ①  
4.50in H x 2.75in W x 1.00in D (11.43cm x 6.98cm x 2.54cm) 0.25lbs (0.12kg)

## Controlling Sound Speaker Volume Controls

- Controls volume of up to 150 one-way speakers
- Stainless steel or white

- I **Speaker Volume Control with Single Gang Box**  
*Stainless Steel* ..... **V-1092** ①  
4.50in H x 2.75in W x 2.00in D (11.43cm x 6.99cm x 5.08cm) 0.80lbs (0.36kg)
- J **Speaker Volume Control w/out Single Gang Box**  
*Stainless Steel* ..... **V-1092B** ①
- J **25/70 Volt Volume Control w/out Single Gang Box**  
*Stainless Steel*..... **S-560**  
4.50in H x 2.75in W x 1.00in D (11.43cm x 6.99cm x 2.54cm) 0.20lbs (0.09kg)
- K **Speaker Volume Control w/out Single Gang Box**  
*White*..... **V-2992-W** ①  
4.50in H x 2.75in W x 2.00in D (11.43cm x 6.99cm x 1.59cm) 0.80lbs (0.45kg)
- L **Speaker Volume Control-Slide Switch w/out Single Gang Box**  
*Stainless Steel* ..... **V-1097** ①  
4.50in H x 2.75in W x 1.25in D (11.43cm x 6.99cm x 3.18cm) 0.25lbs (0.11kg)  
ADA Compliant



### Accessory:

**3RU Rack Mount** — Houses up to 6 Volume Controls

- Volume Control Panel Black**..... **V-VCPANEL-BK**
- Volume Control Panel Gray**..... **V-VCPANEL-GY**  
5.22in H x 19.00in W x 1.00in D (13.62cm x 48.26cm x 2.54cm) 1.30lbs (.50kg)



## Privacy Spot SoundMasking™ Speaker

Valcom's V-9422 Lay-In 2x2 Spot SoundMasking speaker allows you to create a curtain of audible noise that aids in masking conversations that can be easily overheard. Our Spot SoundMasking speaker is an inexpensive approach for healthcare facilities, government agencies, financial institutions, clergy, counselors, human resources and attorneys. The speaker is easily installed and works as both sound source and amplifier, so no additional equipment is necessary. The Spot SoundMasking speaker is separate from your overall communication system. The white noise sound coming from the speaker isn't interrupted when a page is made, and helps you remain compliant with the HIPPA in healthcare settings and uphold confidentiality in office settings.

- Constant 'white noise'
- Built-in electronics and power supply included
- Easy installation - replaces a hallway ceiling tile
- Self-contained with built-in masking source and amplifier

Colors: White (Paintable), Custom Colors -CC

A **2' x 2' Lay-In Spot SoundMasking Speaker** . . . . . **V-9422** **N/A**  
23.75in L x 23.75in W x 3.75in D (60.33cm x 60.33cm x 9.53cm) 5.50lbs (2.48kg)  
ASTM E84



A

Reduces possibility of conversations being overheard by hallway traffic.

Ideal for clergy, human resources, counselors, financial offices and attorneys

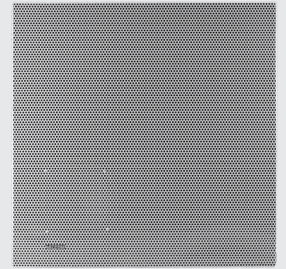

A

## Measuring Sound Volume Control Sensors

*When noise levels change, so do your speakers - automatically*

- Constantly monitors the area and automatically adjusts the volume of the paging speakers
- Use one per zone and/or one per noise area
- Specifications: Output Impedance: 8 Ohm  
Power Requirements: -24Vdc, 100mA

B **Noise Sensing Volume Control** . . . . . **V-9933A** **-2**  
7.30in H x 4.50in W x 2.00in D (18.54cm x 11.43cm x 5.08cm) 0.90lbs (0.41kg)

### Remote Microphone (Must be used with V-9933A) *Measure your environments sound level*

- Self-contained microphone and pre-amp
- No power supply required
- Up to 4 units may be paralleled on one V-9933A

C **Remote Microphone** . . . . . **V-9934** **N/A**  
1.50in H x 2.90in W x 0.81in D (3.81cm x 7.37cm x 2.06cm) 1.00oz (0.03kg)



B



C



# Accessories



A



B



C



D



E

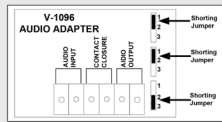

F

Ideal for restaurants, retail stores, bowling alleys, offices, transportation terminals and dispatch centers where a microphone is needed



E

## Microphones

### Microphone Panel with Stored Messages

Record Up to 8 Stored Messages—Microphone for Live Announcements

- Stores and plays up to 8 recorded messages over paging system
- Provides 8 minutes of high quality digital recording
- Eight front panel buttons – for recorded message activation
- Push-to-Talk microphone for live announcements
- Power “ON” & visual system fault indicator
- Easy programming to upload/download voice messages
- Audio interface included (V-1096)

A **Stored Message/Mic Page Panel** ..... **V-9908 -5**  
4.25in H x 5.00in W x 2.00in D (10.80cm x 12.70cm x 5.08cm) 4.00lbs (1.50kg)

### Dynamic Microphones

B **Desk Paging Microphone** ..... **V-400 0**  
**25/70 Volt Mic** ..... **SBS-400**

- Omni-directional pickup pattern
  - Push-to-Talk switch and locking bar
  - Lift-to-Talk switch with bypass slide switch provided
- 9.40in H x 4.00in W x 6.00in D (23.90cm x 10.20cm x 15.24cm) 1.40lbs (0.64kg)

C **Handheld Noise Canceling Microphone** ..... **V-420 0**  
• Handheld with Press-to-Talk lever  
• Heavy duty coil cord extends to 6 feet  
3.94in H x 2.97in W x 2.63in D (10.00cm x 7.54cm x 6.68cm) 0.63lbs (0.29kg)

D **Omni-Directional Gooseneck Microphone** **V-450 0**  
**25/70 Volt Mic** ..... **SDO-450**  
• Omni-directional pickup pattern  
• Push-to-Talk switch  
Microphone: 1.75in Dia x 4.63in L (4.44cm x 11.75cm),  
Gooseneck 19in L (48.26cm) 1.03lbs (0.59kg)

### Accessories:

E **Microphone Adapter** ..... **V-9939C -1**  
• Provides contact closure  
8.25in H x 4.50in W x 2.35in D (20.95cm x 11.43cm x 5.97cm) 0.70lbs (0.32kg)

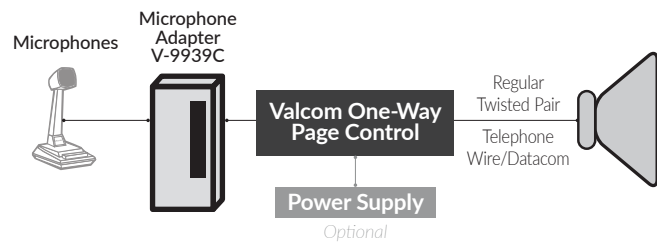

F **Audio Interface** ..... **V-1096 0**  
1.75in H x 3.75in W x 1.25in D (4.45cm x 9.53cm x 3.20cm) 0.50lbs (0.23kg)

**Screw Terminal Block** ..... **VM-150**  
For connecting heavy gauge speaker wire to Amphenol terminated intercom circuit cards





## Paging Expansion

### A Input Line Matching Transformer ..... VMT-1 **NA**

- Functions as output-matching transformer to feed program material Over a 600 Ohm telephone line for “music-on-hold”
- Hi-Z, 10k Ohm primary impedance
- Lo-Z, 600 Ohm secondary impedance, balanced with center tap
- Matches high-to-low impedance or low-to-high impedance
- Adapts line level signals to microphone inputs

1.75in H x 3.75in W x 1.25in D (4.45cm x 9.53cm x 3.18cm) 0.50lbs (0.23kg)

### B Audio Isolation Transformer ..... VMT-2 **NA**

- Magnetically coupling line level audio
- Isolating ground references from one audio circuit to another

1.75in H x 3.75in W x 1.25in D (4.45cm x 9.53cm x 3.18cm) 0.50lbs (0.23kg)

### C Expand 25/70/100 V systems without straining the existing amplifier

#### 70 Volt Expander *Stainless Steel* ..... V-1095 **1**

- Connects to amplifier output or anywhere on 25/70/100 V line
- No costly amplifiers or heavy gauge cable required
- Specifications: Output Impedance: 8 Ohm
- Single gang box

4.44in H x 2.75in W x 2.88in D (11.28cm x 6.99cm x 7.32cm) 0.90lbs (0.41kg)

**Unlimited expansion is a breeze with Valcom amplified speakers**

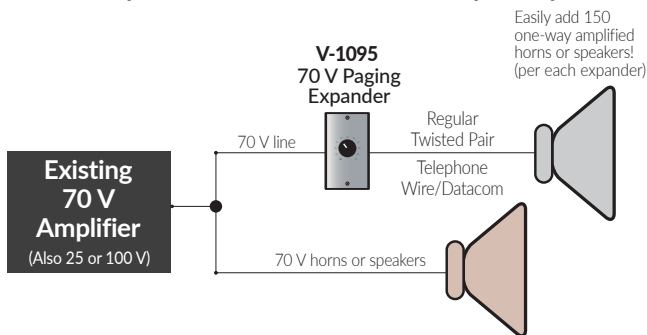

## PreAmp Expanders

Add speakers on and on and on ...

- Pre-amplifies low level audio to remote sites
- Virtually unlimited expansion (150 one-way speakers per box)
- Master volume control for entire system/groups of remote speakers
- Isolates page port from speaker lines
- Specifications: Output Impedance: 8 Ohm  
Power Requirements: -24 Vdc, 45 mA
- Single Gang Box

### D Page Port PreAmp/Expander with Single Gang Box *Stainless Steel* ..... V-1094A **-1**

4.44in H x 2.75in W x 2.88in D (11.28cm x 6.99cm x 7.32cm) 0.80lbs (0.38kg)

### E Page Port PreAmp/Expander *Stainless Steel* ..... V-1094B **-1**

4.44in H x 2.75in W x 0.75in D (11.43cm x 6.99cm x 1.91cm) 0.20lbs (0.09kg)

### F Page Port PreAmp/Expander *White* ..... V-2994-W **-1**

4.50in H x 2.50in W x 2.00in D (11.28cm x 6.99cm x 5.08cm) 0.80lbs (0.36kg)

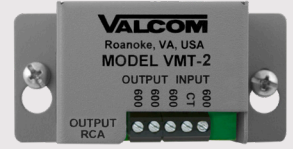

A

B



C

Connects system to most public address amps for phone paging



D



E

## PreAmp Expanders

Add speakers on and on and on ...



F



**2-Channel Mixer**

Expandable to 10 Channels  
- with Remote

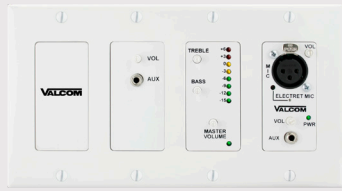

**4-Channel Mixer**



**Remote Module**

### Complete sound system for

- Conference Rooms
- Meeting Rooms
- Lecture Halls
- Sporting Complexes
- Restaurants
- Institutional Cafeterias
- Auditoriums
- Gymnasiums

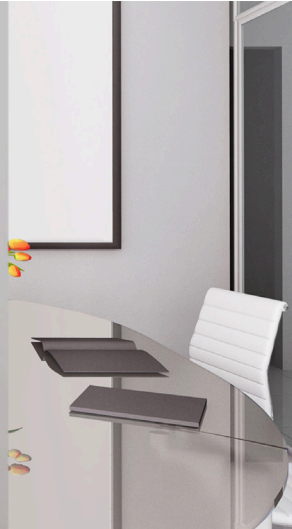

## Managing Sound

### In-Wall Modular Mixer

**Channel Mixers** (Common Features: V-9983-W & V-9985-W)

- Built-in compressor (Option Switch Controlled) for automatic consistent volume level adjustment even when voices vary - low to high
- Master volume control for optimum adjustments and for each input
- 1 general building page input (-10dBm) overrides all others
- Drives 50 amplified speakers/horns
- 8 segment LED meter for visual indication of audio signal levels
- Full frequency range output for speakers
- High pass output horn filter

### Remote Module

- 1 balanced XLR mic input & 1 aux input for MP3 players, CD, DVD or PC's
- Connects to main control module, with 2 pair 24 Awg cable
- Volume control for each input
- Phantom power (switch controlled w/"ON" indicator) allows use of consumer mic

- A 2 Channel In-Wall Mixer** *White* ..... **V-9983-W** -1  
4.25in H x 5.00in W x 2.00in D (10.80cm x 12.70cm x 5.08cm) 0.40lbs (0.18kg)
- B 4 Channel In-Wall Mixer** *White* ..... **V-9985-W** -1  
4.25in H x 6.75in W x 2.00in D (10.80cm x 17.15cm x 5.08cm) 0.65lbs (0.29kg)
- C In-Wall Remote Module** *White* ..... **V-9984-W** -1  
4.25in H x 1.64in W x 2.00in D (10.80cm x 4.17cm x 5.08cm) 0.25lbs (0.11kg)

## Amplifiers

- D 120-Watt Amplifier** *Rack Mount* ..... **SM120**  
Audio power for voice paging or background music systems.  
17.00in W x 12.00in D x 1.75in H (43.23cm x 30.50cm x 4.40cm) 5.10lbs (2.30kg)
- 15-Watt Mixer Amplifiers** *Wall Mount* ..... **SWM-15**
- 35-Watt Mixer Amplifiers** *Wall Mount* ..... **SWM-35A**  
See Website for Dimensions & Weights.

- E Remote Volume Control** ..... **SM-VC**  
The SM-VC allows adjusting the output level of the SM120 Amplifier from a remote location. The SM-VC fits into a standard single-gang electrical box.  
4.50in H x 2.80in W x 1.50in D (11.40cm x 7.11cm x 3.81cm) 0.20lbs (0.09kg)

- F Remote Input Module** *White* ..... **V-9130-W**  
Provides passive stereo to mono for line level audio sources and features both RCA and 3.5mm stereo headphone jack connection options.  
4.13in H x 1.63in W x 1.13in D (10.49cm x 4.14cm x 2.87cm) 1.00lbs (0.45kg)

- G 6 Channel Amplifier** (70 Volt) ..... **V-6120** 0  
• 6 independent channels of amplification  
• Four 10-watt outputs/two 40-Watt outputs  
• Quick release screw terminals  
• Activity LED indicators  
• High pass horn filter on 40-Watt outputs  
• Independent volume controls for each channel  
• Power indicator  
• Transformer coupled inputs  
• 115 - 250 Vac  
3.50in H x 17.00in W x 15.00in D (8.89cm x 43.18cm x 38.10cm) 21.00lbs (9.53kg)

Not Pictured



D



E



F



G



## Eliminate Feedback Digital Stacking Feedback Eliminator

Eliminate busy signals on heavily used paging systems/prevents acoustic feedback

- Multiple messages recorded simultaneously
- Stacks messages - records a page while playing one
- One unit eliminates feedback to ALL zones
- Automatic consistent volume level even when recording voices vary - low to high
- High-fidelity - voice sounds natural not like a recording
- LED Indicators for play, record, busy, power
- Dipswitch features: pre-announce alert tone, priority override (Real time or delayed), DTMF message cancel
- Real time background music input with volume control
- Two audio outputs: 8 and 600 Ohms
- Emergency messages can interrupt play back sequence
- Power requirements: -24 Vdc, 250 mA
- Multiple units can be stacked for additional inputs
- Can provide provide feedback elimination on one zone or all zones when connected in front of a multizone page control

### A Stacking Feedback Eliminator ..... V-9964 -6

11.76in H x 7.10in W x 1.72in D (29.87cm x 18.03cm x 4.37cm) 2.60lbs (1.18kg)



A

Tired of having a squeal over paging speakers when you page?



## Background Music Message-On-Hold USB Devices

A solid-state digital message repeater installs easily into any messaging application that requires triggered, continuous or timed message play

- Messages and MP3 files are stored on 16MB - 4GB USB flash drives
- Playback quality up to 128 Kbps
- Built-in monitor speaker
- LED status indicator
- Store up to 99 messages
- Triggered and/or timed playback
- Active output indication trigger
- Auxiliary 12 Vdc output for wiring sensors
- Power supply included

### B USB Multi-Messenger Device ..... V-9989 0

5.10in H x 6.30in W x 1.75in D (12.95cm x 16.00cm x 4.45 cm) 2.40lbs (1.08kg)

### C USB Message-On-Hold Device ..... V-9988 0

5.10in H x 6.03in W x 1.75in D (12.95cm x 15.32cm x 4.45cm) 2.10lbs (1.04kg)



B



C

Sell your products and services while you have your customers on-hold!





A



B



C



D



E

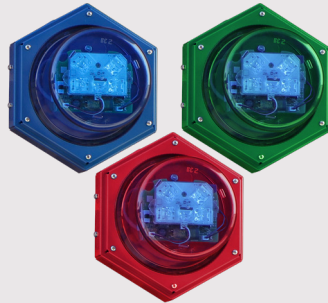

F



G



H



## Audible Alerting – Tones

### Loud Ringer Horns

- 90 Vac ring or 18 Vac buzzer voltage activation
- Connects directly to PBX station port
- Built-in tone generator, 5-Watt amplifier and volume control

A **Loud Warble Ringer Horn** ..... **V-9925A** -10

6.50in H x 8.20in W x 10.40in D (16.51cm x 20.83cm x 26.42cm) 3.60lbs (1.63kg)

B **Single Tone Warble Horn** Power Supply Included ..... **V-9945A** 

6.50in H x 8.20in W x 10.40in D (16.51cm x 20.83cm x 26.42cm) 4.30lbs (1.95kg) FCC Part 15

## Add Tones Over Paging

Up to 8 different tones with a single unit: choice of 2 sets of 8 different tones

- Siren Evacuation\* • Steady Shift Changes\* • Chime Doorbutton/Code Call
- Whoop Tornado\* • Burst Alarm Signal\* • Dual Chime Doorbell Ring
- Warble Fire\* • TeleBell Auxiliary Ring \*USA Standard Immediate Evacuation Signals

C **Multi-Tone Generator** ..... **V-9927A** -2

8.20in W x 4.55in H x 2.30in D (20.83cm x 11.56cm x 5.84cm) 1.40lbs (0.68kg)

D **C.O. Line Audible Ring Unit – 6 Lines** ..... **V-9936A** -4

- 90 Vac ring or dry contact closure activation • Automatically overrides page or music
- Connects directly up to 6 C.O. or PBX station lines
- Contact closure output to activate loud bells • Built-in warble tone generator

8.20in H x 4.55in W x 2.30in D (20.83cm x 11.56cm x 5.84cm) 1.50lbs (0.68kg)

E **C.O. Line Audible Ring Unit – 1 Line** ..... **V-9924C** -6

- 90 Vac, 18 Vac, or dry contact closure activation
- Connects to analog PBX station port
- Provides 3 separate zone outputs and volume controls
- Automatically overrides page or music

8.20in H x 4.55in W x 2.30in D (20.83cm x 11.56cm x 5.84cm) 1.30lbs (0.59kg)

## Visual Alerting – Strobes

Flash of light to get attention in noisy areas where paging can't be heard

F **IP Strobe, Indoor/Outdoor** Blue -BL, Green -GN, Red -RD, ... **VIP-997-color**

**InformaCast®** ..... **VIP-997-color-IC**

**IntradoRevolution®** ..... **VIP-997-color-SA**

Larger size is an ideal fit for gymnasiums or manufacturing plants

- Night ring functionality in conjunction with other Valcom IP speakers
- Synchronized strobing when used with additional Valcom IP strobes

9.00in H x 7.80in W x 5.5in D (22.86cm x 19.80cm x 13.97cm) 3.30lbs (1.50kg)

G **IP Strobe** Amber -AM, Blue -BL, Green -GN, Red -RD, White -WH, ... **VIP-998-color**

**InformaCast®** ..... **VIP-998-color-IC**

**IntradoRevolution®** ..... **VIP-998-color-SA**

- Can activate multiple strobes via single SIP call • Indoor

- Activate on group audio • PoE, 15,30,75,95,110 Candela

5.50in H x 5.00in W x 2.00in D (13.90cm x 12.70cm x 5.08cm) 0.62lbs (0.28kg)

G **Strobe** Amber -AM, Blue -BL, Green -GN, Red -RD, White -WH, ... **V-998-color** 0

**110 candela of brilliancy strobe, covers 70 ft by 70 ft area • Indoor**

- Power supply included • **V-9955** Auxiliary Relay Unit for strobe activation, door and camera control • Activated by applying power, dry contact closure, 70 V speaker voltage

**CAUTION: DO NOT USE 2 STROBES WITHIN SAME FIELD OF VIEW**

5.50in H x 5.00in W x 2.00in D (13.90cm x 12.70cm x 5.08cm) 0.62lbs (0.28kg)

H **Auxiliary Relay Unit** ..... **V-9955** 0

**for Strobe Activation, Door Control, Camera Control**

- Three 24 Vdc 2 pole relays with 1 Amp contacts

- Independent control or simultaneous operation of relays

11.76in H x 7.10in W x 1.72in D (29.87cm x 18.03cm x 4.37cm) 2.60lbs (1.18kg)

I **Threat Level Indicator** ..... **VIP-996**

- Both power/activation provided by the IP network

- Bright LEDs in three colors: Red, Yellow, Green

4.55in H x 4.55in W x 1.50in D (11.55cm x 11.55cm x 3.81cm) 0.45lbs (0.20kg)

J **Threat Level Indicator Add-On to VL520/VL550** ..... **VL-TL3**

Ideal for a variety of scenarios where visible alerting by colors are needed.

*Does not work with the InformaCast® and IntradoRevolution® Versions*

5.50in H x 1.75in W x 0.50in D (13.97cm x 4.44cm x 1.27cm) 0.13lbs (0.06kg)

## Lights and Sounds for different situations

# Accessories

## IP Interactive Console/Panels

Quickly activate emergency alerts and streamline daily communications with easy browser-based scheduling options. Users are able to receive and initiate intercom calls to IP endpoints throughout your organization as well as broadcast public address announcements. Powered by PoE+ or 12 Vdc.

- A **IP Interactive Console** ..... **VIP-893\***
- IP Interactive Console with Scheduling** ..... **VIP-893S**
- Scheduler Firmware Upgrade** for customers with VIP-893 ... **L893-S**
- B **IP Building Communication Panel with Scheduling** ... **VIP-895-S**
- C **IP Emergency Communication Panel** ..... **VIP-895-E\***

## LED Visual Message Signs

Utilized for broadcasting visual and voice message alerts including daily or emergency alerts

- RJ45 for network connection • Network activity LEDs
- IP set up for configuration • Supervised/monitoring
- Static or DHCP configurable
- Visual message maybe programmed for one or two lines with options for color, transitions and fonts

### 20-Inch Wide

- D **IP Speaker-with-Text and Flashers, Black** ... **VL520BK-F-FC\***
- InformaCast®** ..... **VL520BK-F-FC-IC\***
- IntradoRevolution®** ..... **VL520BK-F-FC-SA\***
- E **IP Speaker-with-Text and Flashers, Metallic** ... **VL520M-F-FC\***
- InformaCast®** ..... **VL520M-F-FC-IC\***
- IntradoRevolution®** ..... **VL520M-F-FC-SA\***

20.38in W x 5.50in H x 2.50in D (51.80cm x 14.00cm x 6.40cm) 4.65lbs (2.10kg)

### 20-Inch Wide, Double-Sided

- F **IP Speaker-with-Text and Flashers, Black** ... **VL522BK-F-FC\***
- InformaCast®** ..... **VL522BK-F-FC-IC\***
- IntradoRevolution®** ..... **VL522BK-F-FC-SA\***
- G **IP Speaker-with-Text and Flashers, Metallic** ... **VL520M-F-FC\***
- InformaCast®** ..... **VL522M-F-FC-IC\***
- IntradoRevolution®** ..... **VL522M-F-FC-SA\***

22.50in L x 5.40in W (top)/ 3.80in W (bottom) x 5.55in H  
(57.20cm x 13.70cm (top)/ 9.70cm (bottom) x 14.10cm) 7.00lbs (3.10kg)  
Mounting Bracket: 7.25in W x 8.00in H x 1.40in D (18.40cm x 20.30cm x 3.60cm)

### 40-Inch Wide

- H **IP Speaker-with-Text and Flashers, Black** ... **VL550BK-F-FC\***
- InformaCast®** ..... **VL550BK-F-FC-IC\***
- IntradoRevolution®** ..... **VL550BK-F-FC-SA\***
- I **IP Speaker-with-Text and Flashers, Metallic** ... **VL550M-F-FC\***
- InformaCast®** ..... **VL550M-F-FC-IC\***
- IntradoRevolution®** ..... **VL550M-F-FC-SA\***

41.75in L x 5.88in H x 3.00in D (Top), 2.50in D (Bottom)  
(106.00cm x 14.90cm x 7.60cm (top) x 6.40cm (Bottom))

### Accessories:

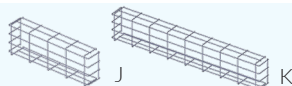

- J **Wire Guard for VL-520 (2 Pack)** ..... **V-WGVL520-2**
- 22.90in L x 7.20in H x 4.00in D (58.20cm x 18.30cm x 10.20cm) 2.50lbs (1.13kg)
- K **Wire Guard for VL-550 (2 Pack)** ..... **V-WGVL550-2**
- 44.50in W x 7.20in H x 4.00in D (113.00cm x 18.30cm x 10.20cm) 4.40lbs (2.00kg)

## L 80-Inch Wide Outdoor LED Sign

- IP PoE Outdoor LED Sign, Black** ..... **VL590-RG**
- InformaCast®** ..... **VL590-RG-IC**
- IntradoRevolution®** ..... **VL590-RG-SA**

Send live voice, pre-recorded audio files, and text with the touch of a button.

Easy browser-based scheduling



Easy browser-based scheduling



Be prepared with ShakeAlert™ capability for added safety

**VALCOM**

**Earthquake Early Warning**

Powered by **ShakeAlert** California | Oregon | Washington



New 7-Color LEDs



+

Multilingual Speakers-with-Text & Flashers

D

E

Wall Mount



Ceiling Mount



F

G



H

I

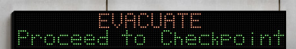

80-Inch Wide Outdoor LED Sign

L







**Always  
on Duty.**

Single button press provides immediate two-way connection with security personnel.

## IP Emergency HelpPoint Call Tower

Notification broadcast - parking lots, athletic fields & pathways

### FEATURES

#### Sleek, Modern Design

Lightweight Aluminum and Vandal-Resistant

#### 1 or 2 Call Buttons

Lighted LED Emergency Button

#### High-Intensity Blue LED Light

Always On and Flashes During Emergency Calls

### FUNCTIONS

#### Caller ID

For Precise Location

#### Hands-Free Intercom Operation

When Called Party Answers, Instant Hands-Free Communication is Enabled

#### 360-Degree Speaker Array

One-Way High-Level Audio Broadcasting for Emergency Broadcasts

#### Optional IP Camera

For Emergency Viewing

#### Emergency Listening

Programmable Silent Activate Mode

### DURABILITY

#### Security Type Hardware

Corrosion and Vandal-Resistant

#### Durable Manufacturing

Structural Grade Corrosion Proof Aluminum

#### Clear Dome

Durable UV-Resistant Polycarbonate Material

### COMPATIBILITY

#### MultiCast Paging

Valcom, InformaCast®, or Intrado Revolution® Protocols

#### Compatible with

Valcom, Cisco®, Avaya®, Mitel®, NEC®, and most other SIP-Based Systems, including Hosted or On-Premise

#### Easy Software

For Set-Up and Management – Supervision Software Available

#### Power

Multiple Power and Network Connectivity Options

#### OPTIONS:

- Power: PoE+, AC/DC
- Camera Arm Mount
- Colors and Lettering
- Standard "Emergency" Button or additional 2nd "Call" Button

#### BASE TOWER



360-Degree Speaker Array

#### OPTIONS:

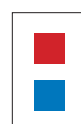

Colors



Camera

A	IP PoE Emergency Call Tower	VE9811
	InformaCast®	VE9811-IC

Approximately 114.00in H x 10in Dia (289.56cm x 25.40cm) 75.00lbs (32.70kg)

Call for configuration assistance and pricing.

## SIP Vandal-Resistant Emergency Call Station

Provides high visible security for hallways, transit centers, building/dorm entrance and parking decks

- Easy, RJ-45 Plug-in, CAT 5 or 6
- Call button calls a SIP address or any Valcom Gateway device
- SIP or Multicast addressable
- Red LED status indicator
- Network programmable for control and setup
- Automatic talkback VOX operation (no push-to-talk button needed)
- Compatible with most modern IP telephone systems
- Blue flashing light

- B **Emergency Call Station** ..... **VIP-9895**  
**InformaCast®** ..... **VIP-9895-IC**  
 32.15in H x 9.90in W x 8.00in D (81.66cm x 25.10cm x 20.30cm) 39.75lbs (18.10kg)

## SIP Multi-Button Emergency/Information Call Station

- 1, 2, 3 or 4 call programmable call buttons
  - emergency, general, directions, recorded information
- Emergency calls take precedence over all other calls
- Convenient "Voice Operated Switch" VOX operation
- Flush, surface mount

- C **Multi-Button Call Station** ..... **VIP-9894**  
**InformaCast®** ..... **VIP-9894-IC**  
 14.62in H x 9.87in W x 5.07in D (37.20cm x 25.10cm x 12.90cm) 5.00lbs (2.30kg)

## SIP Vandal-Resistant Emergency Call Station

- Loud horn for large areas
- Door relay connection
- Surface mount steel enclosure
- Stainless steel faceplate

- D **IP Call Station** ..... **VIP-9890A-EM**  
**InformaCast®** ..... **VIP-9890A-EM-IC**  
**IP Call Station Long Line Extender** ..... **VIP-9890AL-EM**  
**InformaCast® Long Line Extender** ..... **VIP-9890AL-EM-IC**  
 10.00in H x 12.50in W x 4.00in D (25.40cm x 31.75cm x 10.20cm) 10.75lbs (4.89kg)

## SIP Vandal-Resistant Call Station

- Door relay connection
- Surface mount steel enclosure
- Stainless steel faceplate

- E **IP Intercom/Doorphones Long Line Extender** ..... **VIP-9890AL-CB**  
**InformaCast® Long Line Extender** ..... **VIP-9890AL-CB-IC**  
 10.00in H x 12.50in W x 4.00in D (25.40cm x 31.75cm x 10.20cm) 10.75lbs (4.89kg)

## IP Repurpose Emergency Call Plate

Allows retrofit of existing analog emergency telephone enclosures to provide advanced IP features such as page broadcasts, all call and monitoring (Ex; Code Blue, Talk-A-Phone, Gai-tronics)

- F **IP Repurpose Emergency Call Plate** ..... **VE9870A**

See website for dimensions and weights.

Wall or Pole Mount



Interior/Exterior

B



Interior/Exterior

C



Interior

D



Interior

E

Retrofit to provide Advanced IP features



Interior/Exterior

F



Interior/Exterior

B



Colors

Available in: Red, Blue, Yellow and Gray.

Call for configuration assistance & pricing.





A



B



C



D



E



F



G



H



I



J



K



L

## IP PoE Clocks

### Analog

A **12-Inch** ..... **VIP-A12A**  
12.81in Dia x 1.20in D (32.54cm x 3.05cm) 3.70lbs (1.68kg)

B **16-Inch** ..... **VIP-A16A**  
16.81in Dia x 1.60in D (42.70cm x 4.06cm) 5.35lbs (2.43kg)

### Double-Sided

C **12-Inch** ..... **VIP-A12ADS**  
12.81in Dia x 7.00in D (32.54cm x 17.78cm) 11.00lbs (4.99kg)

D **16-Inch** ..... **VIP-A16ADS**  
16.81in Dia x 7.25in D (42.70cm x 18.42cm) 12.60lbs (5.72kg)

### Digital

#### 4-Digit **HH:MM**

E **2.5-Inch Numbers** ..... **VIP-D425A**  
10.65in L x 3.00in W x 4.90in H (27.05cm x 7.62cm x 12.45cm) 2.88lbs (1.31kg)

F **4.0-Inch Numbers** ..... **VIP-D440A**  
17.00in L x 3.00in W x 6.75in H (43.18cm x 7.62cm x 17.14cm) 5.10lbs (2.31kg)

#### 4-Digit Double-Sided

G **2.5-Inch Numbers** ..... **VIP-D425ADS**  
11.50in L x 4.25in W x 5.50in H (29.21cm x 10.80cm x 13.97cm) 5.90lbs (2.68kg)

H **4.0-Inch Numbers** ..... **VIP-D440ADS**  
17.38in L x 4.25in W x 6.85in H (44.15cm x 10.80cm x 17.40cm) 9.10lbs (4.14kg)

#### 6-Digit **HH:MM:SS**

I **2.5-Inch Numbers** ..... **VIP-D625A**  
15.30in L x 3.00in W x 4.90in H (38.86cm x 7.62cm x 12.45cm) 3.85lbs (1.75kg)

J **4.0-Inch Numbers** ..... **VIP-D640A**  
24.75in L x 3.00in W x 6.75in H (62.87cm x 7.62cm x 17.15cm) 7.07lbs (3.21kg)

#### 6-Digit Double-Sided

K **2.5-Inch Numbers** ..... **VIP-D625ADS**  
16.12in L x 4.25in W x 5.50in H (40.94cm x 10.80cm x 13.97cm) 7.30lbs (3.10kg)

L **4.0-Inch Numbers** ..... **VIP-D640ADS**  
25.25in L x 4.25in W x 6.85in H (64.14cm x 10.80cm x 17.40cm) 12.20lbs (5.45kg)

### Accessories:

Double-sided comes with mounting bracket/hardware for either wall or ceilings. (To attach to ceiling tile use V-9914M-5 Bridge - See page 9.)

V-9914M-5

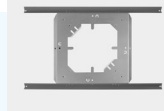



# Clocks — Wired + Wireless

## Wireless Clocks

### Analog

- A **12-Inch, Battery Operated** ..... **V-AW12B**
- B **12-Inch, Military Dial**..... **V-AW12B-MD**
- C **12-Inch, 110 Vac/24 Vdc**..... **V-AW12BLP**  
12.65in Dia x 2.18in D (32.13cm x 5.54cm) 2.50lbs (1.13kg)
- D **16-Inch, Battery Operated** ..... **V-AW16B**
- E **16-Inch, 110 Vac/24 Vdc**..... **V-AW16BLP**  
16.65in Dia x 2.18in D (42.29cm x 5.54cm) 4.00lbs (1.81kg)

### Digital

#### 4-Digit **HH:MM**

- F **2.5-Inch Numbers, 110 Vac** ..... **V-DW11025B**  
7.50in H x 11.38in W x 4.25in D (19.05cm x 28.91cm x 10.80cm) 2.00lbs (0.91kg)
- G **4.0-Inch Numbers, 110 Vac** ..... **V-DW11040B**  
9.75in H x 14.25in W x 4.25in D (24.77cm x 36.20cm x 10.80cm) 3.50lbs (1.59kg)

## Wired Clocks

### Analog

- H **12-Inch, 24 Vdc**..... **V-A2412B -1**
- H **12-Inch, 110 Vac** ..... **V-A11012B**  
12.81in Dia x 1.50in D (32.54cm x 3.81cm) 4.00lbs (1.81kg)
- I **16-Inch, 24 Vdc**..... **V-A2416B -1**
- I **16-Inch, 110 Vac** ..... **V-A11016B**  
16.81in Dia x 1.60in D (42.70cm x 4.06cm) 6.00lbs (2.72kg)

### Digital

#### 4-Digit **HH:MM**

- J **2.5-Inch Numbers, 24 Vdc**..... **V-D2425B -3**  
4.69in H x 10.31in W x 3.90in D (11.91cm x 26.19cm x 9.91cm) 1.30lbs (0.59kg)
- K **4.0-Inch Numbers, 24 Vdc**..... **V-D2440B -4**  
6.75in H x 13.31in W x 6.75in D (17.15cm x 33.81cm x 9.80cm) 3.50lbs (1.59kg)

See website for dimensions and weights.



A & C



B



D & E



F



G



H



I



J



K



Proven  
Time-Keeping  
Accuracy and  
Reliability

# Clocks Accessories

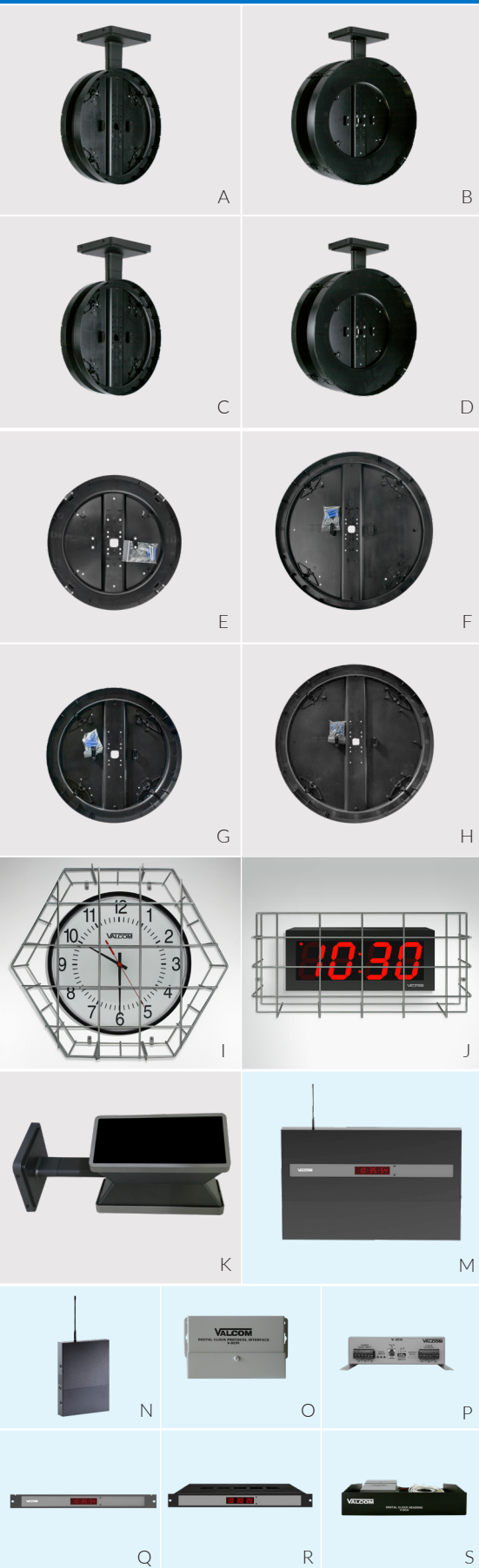

See website for dimensions and weights.

## Analog Accessories

### Double-Sided Brackets for Wireless Clocks

- A 12-Inch Clocks ..... [V-WDM12](#)
- B 16-Inch Clocks ..... [V-WDM16](#)

### Double-Sided Brackets for Wired Clocks

- C 12-Inch Clocks ..... [V-BDM12-S](#)
- D 16-Inch Clocks ..... [V-BDM16-S](#)

### Surface Mounting for Wired Clocks

- E 12-Inch Clocks ..... [V-SMR12A](#)
- F 16-Inch Clocks ..... [V-SMR16A](#)

### Surface Mounting for Wireless Clocks

- G 12-Inch Clocks ..... [V-SMR12AW](#)
- H 16-Inch Clocks ..... [V-SMR16AW](#)

- I Wire Guards  
for 12 and 16-Inch Analog Clocks ..... [V-WGACLK](#)

## Digital Accessories

- J Wire Guards  
for 4-Digit Digital Clocks ..... [V-WGD4](#)

- K Double-Sided Brackets  
for 4-Digit Digital Clocks ..... [V-DMKIT](#)

## Clock Controls & Drivers

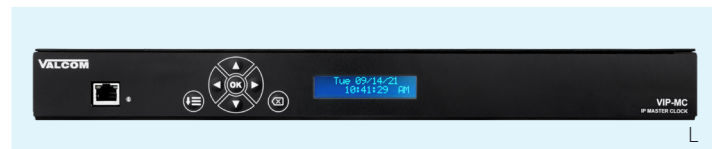

- L IP Master Clock ..... [VIP-MC](#)

Features built-in correction relays and the protocols to correct most industry standard clocks. It also features BCD and Valcom 2-wire digital correction protocols. Setup is easy via the front panel LCD display, a built-in web GUI or the Valcom VIP-102B IP Solutions Setup Tool

- M Wireless Master Clock Transceiver ..... [V-WMCA](#)

- N Wireless Repeater ..... [V-WMCA](#)

Must be used with a V-DCPI Digital Clock Protocol Interface, a V-GPSA GPS Receiver, V-WMCA Wireless Master Clock or a VIP-MC

- O Digital Clock Protocol Interface ..... [V-DCPI](#)

- P Clock Interface Controller Kit ..... [V-VCU](#)

- Q GPS Master Clock Wireless ..... [V-GPS-TX](#)

- R GPS Master Clock Wired ..... [V-GPSA](#)

Using Valcom Wired Clock (2-wire correction), Add 6 Amp 2-Wire Clock Driver (V-VCU)

- S Digital Clock Head End Driver, 2-Wire ..... [V-DCH](#)



# IP Clock/Speaker Combos

## Analog – Flush Mount *Colors: White, Custom Colors -CC*

- A **One-Way or Talkback Programmable** ..... **VIP-429A-A**  
**InformaCast®** ..... **VIP-429A-A-IC**  
**IntradoRevolution®** ..... **VIP-429A-A-SA**  
 14.50in H x 13.00in W x 3.40in D (36.93cm x 33.02cm x 8.64cm) 4.80lbs (2.18kg)
- B **Talkback, InformaCast®** ..... **VIP-431A-A-IC**  
 20.28in H x 14.38in W x 4.50in D (51.51cm x 36.53cm x 11.43cm) 4.25lbs (1.91kg)



A



B

## Digital – Flush Mount *Colors: White, Custom Colors -CC*

- C **6-Digit HH:MM:SS**  
**One-Way or Talkback Programmable** ..... **VIP-426A-D**
- D **4-Digit HH:MM**  
**One-Way or Talkback Programmable** ..... **VIP-429A-D**  
**InformaCast®** ..... **VIP-429A-D-IC**  
**IntradoRevolution®** ..... **VIP-429A-D-SA**  
 14.50in H x 13.00in W x 3.40in D (36.93cm x 33.02cm x 8.64cm) 4.80lbs (2.18kg)



C



D

*Backboxes for A, C, D*

**Angled Mount** ..... **VB-A24**  
 14.48in H x 13.13in W x 5.00in D1 x 2.97in D2  
 (36.78cm x 33.35cm x 12.70cm)



**Recessed Mount** ..... **VB-R22**  
 13.25in H x 11.25in W x 3.75in D (33.66cm x 28.58cm x 9.53cm)



**Surface Mount** ..... **VB-S23**  
 14.63in H x 13.13in W x 3.94in D (37.16cm x 33.35cm x 10.01cm)



E



F

## Digital – Flush Mount *Colors: Gray, Custom Colors -CC*

- E **4-Digit HH:MM**  
**One-Way or Talkback Programmable Gray** ..... **VIP-432A-DF**  
**InformaCast® Gray** ..... **VIP-432A-DF-IC**  
 20.28in H x 14.38in W x 3.40in D (51.51cm x 36.53cm x 8.64cm) 4.25lbs (1.91kg)

*Backboxes for B & E*

**Angled Mount** ..... **VB-A21**  
 19.88in H x 14.27in W x 6.27in D1 x 2.72in D2  
 (50.50cm x 36.25cm x 15.93cm D1 x 6.91cm D2)



**Recessed Mount** ..... **VB-R19**  
 19.25in H x 10.75in W x 3.75in D (48.90cm x 27.31cm x 9.23cm)



**Surface Mount** ..... **VB-S20**  
 20.18in H x 14.27in W x 2.78in D (51.26cm x 36.25 x 7.06cm)



## Angled Surface Mount - Digital *Colors: Gray, Custom Colors -CC* *(No Backbox Required)*

- F **4-Digit HH:MM**  
**One-Way InformaCast®** ..... **VIP-411A-DS-IC**
- One-Way or Talkback Programmable** ..... **VIP-431A-DS**  
**InformaCast®** ..... **VIP-431A-DS-IC**  
**IntradoRevolution®** ..... **VIP-431A-DS-SA**  
 14.90in H x 12.40in W x 4.80in D1 (top, with grille) 1.40in D2 (bottom)  
 (37.80cm x 31.50cm x 12.20cm (D1) 3.60cm (D2) 4.25lbs (1.90kg)



D



# IP Speaker Clock Kits

## One Network Connection A Convenient IP Speaker Clock Kit for Classrooms

- Provides synchronized time, talkback and loudspeaker paging capabilities
- Clock synchronizes using Network Time Protocol (NTP)
- IP Speaker Clock Kit acts as a single endpoint
- Requires only one network port connection
- Power over Ethernet provides power to both the clock and speaker
- 50ft of pre-terminated cable included for speaker-to-clock-connection
- Optional call-in buttons available for emergency call and/or lockdown confirmation [page 22]

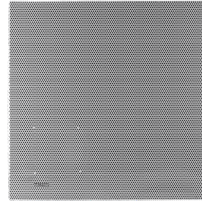

2x2 Lay-In Ceiling Speaker  
with Analog Clock  
One-Way or Talkback Programmable  
InformaCast®  
**VIP-4122-A12-IC**

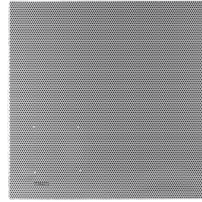

2x2 Lay-In Ceiling Speaker  
with Digital Clock  
One-Way or Talkback Programmable  
InformaCast®  
**VIP-4122-D44-IC**



Wall Speaker  
with Analog Clock  
One-Way or Talkback Programmable  
InformaCast®  
**VIP-4171-A12-IC**

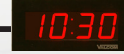

Wall Speaker  
with Digital Clock  
One-Way or Talkback Programmable  
InformaCast®  
**VIP-4171-D44-IC**

Single Port Device™



SIP Technology

Acts as a  
Single Endpoint

Requires only  
1 Network Port

50ft Cable  
Included

PoE

**Synchronized time, talkback  
and loudspeaker paging capabilities**

50ft Cable  
Included





# Assemblies of Speakers or Clock/Speakers

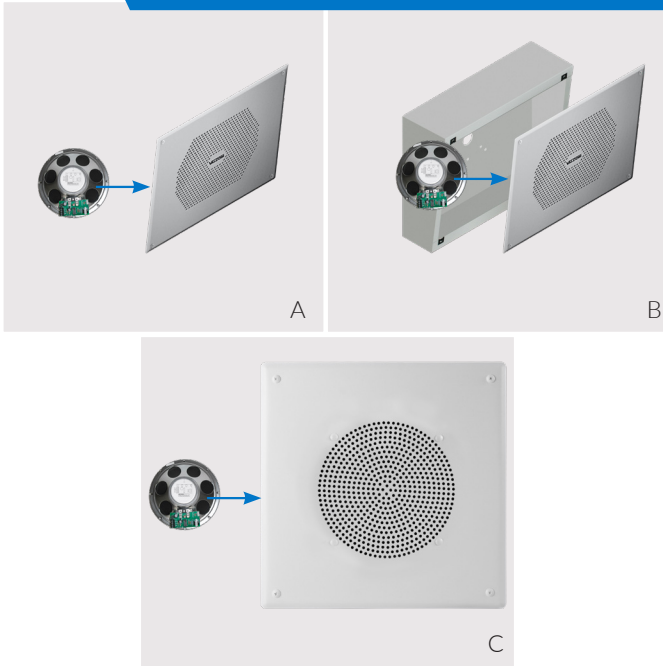



## Speaker Assemblies

### Choose Faceplate

- A **Vandal-Resistant Faceplate Recessed Mount** ..... **V-9808**
  - Heavy Gauge Steel Construction (Indoor)
  - Colors: Gray (Paintable), Custom Colors -CC
  - 10.00in H x 12.25in W x 16 GA (25.40cm x 31.12cm x 16 GA) 2.40lbs (1.10kg)
- B **Vandal-Resistant Faceplate & Enclosure Surface Mount** ..... **V-9807**
  - Heavy Gauge Steel Construction (Indoor)
  - Colors: Gray (Paintable), Custom Colors -CC
  - 10.00in H x 12.25in W x 4.00in D (25.40cm x 31.12cm x 10.16cm) 7.00lbs (3.20kg)
- C **Square Grille** ..... **V-936480**
  - Designed for Mounting 8-Inch Speaker Assembly
  - Colors: White (Paintable), Custom Colors -CC
  - 11.50in L x 11.50in L x 0.20in D (29.21cm x 29.21cm x 0.51cm) 1.00lbs (0.45kg)

### Choose Backbox for V-936480

- Angled Mount** ..... **VB-A13**

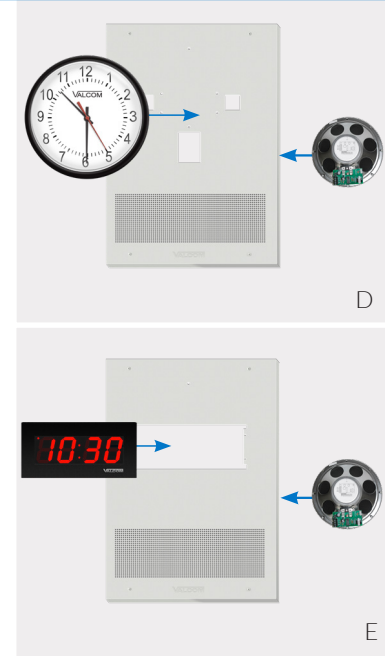
  - 11.54in H x 11.63in W x 4.60in D1 x 3.15in D2
  - (29.31cm x 29.54cm x 11.68cmD1 x 8.00cmD2) 3.40lbs (1.53kg)
- Recessed Mount** ..... **VB-R12**

  - 10.75in H x 10.75in W x 3.94in D (27.31cm x 27.31cm x 10.01cm) 3.00lbs (1.35kg)
- Surface Mount** ..... **VB-S11**

  - 11.63in H x 11.63in W x 3.94in D (29.54cm x 29.54cm x 10.01cm) 3.50lbs (1.58kg)



## Clock/Speaker Assemblies



See pages 34-35 for Clocks

### Choose Faceplate

Color: White, Light Texture Powder Paint

- D **Analog Baffle for 12-Inch Clock & 8-Inch Speaker** ..... **V-CSB12S**  
20.32in H x 14.41in W x 0.56in D (51.44cm x 36.53cm x 1.42cm) 2.40lbs (1.09kg)
- E **Digital Baffle for 4 Digit, 2.5-Inch Clock & 8-Inch Speaker** .. **V-CSB25**  
20.25in H x 14.38in W x 0.56in D (51.44cm x 36.53cm x 1.42cm) 2.40lbs (1.09kg)

### Choose Backbox

- Angled Mount** ..... **VB-A21**

  - 19.88in H x 14.27in W x 6.27in D1 x 2.72in D2
  - (50.50cm x 36.25cm x 15.93cmD1 x 6.91cmD2)
- Recessed Mount** ..... **VB-R19**

  - 19.25in H x 10.75in W x 3.75in D (48.90cm x 27.31cm x 9.23cm)
- Surface Mount** ..... **VB-S20**

  - 20.18in H x 14.27in W x 2.78in D (51.26cm x 36.25 x 7.06cm)



### Choose 8-Inch Speaker Assemblies





- F **24 V (w/Amplifier)** ..... **VSA-1020C** ①  
8.00in Dia x 2.25in D (20.32cm x 5.72cm) 2.50lbs (1.13kg)
- G **45 Ohm Talkback (4 Volume)** ..... **V-936418** ②  
8.00in Dia x 2.75in D (20.32cm x 6.99cm) 1.30lbs (0.59kg)
- H **25/70 V** ..... **V-936400** ②  
8.0in Dia x 2.25in D (20.32cm x 5.72cm) 1.70lbs (0.77kg)



# Easy 1-2-3 Analog Design System

## Step 1

Number of zones      One-way broadcast only      or      Talkback      Special features

Select a Page Control		One-Way Page Controls				Talkback Page Controls	
		V-2000A	V-2001A	V-2003A	V-2006A	V-2003AHF	V-2006AHF
Number of Zones		1	1	3	6	3	6
Features	Background Music	•	•	•	•	•	•
	All Call	•	•	•	•	•	•
	Group Call				•		•
	Emergency Page Override		•	•	•	•	•
	Night Ring/Time Clock Tones		•	•	•	•	•
	Valcom Power Units Provided	+ 12	+ 20	+ 20	+ 30	+ 10	+ 20
Telephone Access	<b>FXO</b> PBX Loop Start Trunk Port Electronic Key Line Position Dedicated Single Line Phone Set 	•	•	•	•	•	•
	<b>FXO</b> PBX Ground Start Trunk Port 			•	•	•	•
	<b>Audio Port</b> Page Port (Telephone System Dependant) 	•	•	•	•	•	•
	<b>FXS</b> Centrex or C.O. Line PBX Analog Station Port (Loop Disconnect Required) 	Add V-9972				Add V-9972 or Add V-9940	

Look for these orange symbols when selecting page controls

## Step 2

Area to be paged in square feet      Determine ceiling heights & type      Noise levels

Speaker/Horn Placement Guide					Shows SPACE Between Horns & Square Foot Coverage PER Horn						
Speakers	Ceiling Height x 2 = Speaker Placement Example: 8ft Ceiling x 2 = Space Speakers 16ft Apart				Horns	Quiet 50-65dB	Moderate 65-80dB	Noisy 80-90dB	Very Noisy 90+dB		
	Wall Speaker Placement Spaced 20ft Apart (One Per 600 sq. ft.)					5-Watt	110ft (12,000sq.ft)	80ft (6,400sq.ft)	50ft (2,500sq.ft)	30ft (900sq.ft)	
						15-Watt	-	-	75ft (5,600sq.ft)	45ft (2,000sq.ft)	
						30-Watt	-	-	-	60ft (3,600sq.ft)	
Power Pair Run											
# Interior Speakers	Number of Speakers/Horns Per Power Run				Power Run Wire Length in Feet						
	Signature Series™	Flex Horns	5-Watt Horns	15/30-Watt Horns	24 AWG	22 AWG	20 AWG	18 AWG	16 AWG		
4	1	-	-	-	1000ft	1600ft	2500ft	4000ft	6400ft		
7	2	1	1	-	500ft	800ft	1280ft	2025ft	3220ft		
15	4	2	2	-	250ft	400ft	640ft	1010ft	1610ft		
30	8	4	4	1	125ft	200ft	320ft	500ft	805ft		

## Step 3

The amount of power required for a paging system is based on the quantity and type of page control and speakers/horns selected. Valcom Products are assigned Valcom Power Units (VPU)

Products Either Provide **+ #** or Consume **- #** Power

### Valcom Power Units VPU's — Make it easy!

**Simply Total All:**

- Page Control VPU's
- Speaker/Horn VPU's
- Subtract b. from a.

**Example:**

Page Control	1	x	<b>+30</b>	=	+ 30 VPU Provided
Speakers	15	x	<b>-1</b>	=	- 15 VPU Consumed
				=	<b>+ 15 VPU's LEFT OVER</b>

**NO Additional Power Supply needed!**

- Products that neither consume NOR provide power are a 0
- Note: one Valcom Power Unit = 50 mA., -24 Vdc
- VPU listings are on the product pages & index
- Have VPU's left over - You can add more speakers!
- Need more - Simply select a Power Supply (page 25) with enough VPU's to make up the difference!



# Descriptive Index

Description Part # VPU Pg #

## CEILING SPEAKERS

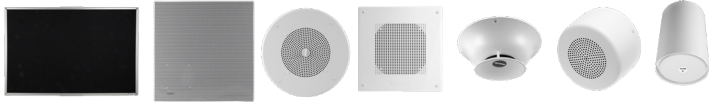

### Sound360° Flat Panel Speaker

IP One-Way or Talkback Programmable	VIP-2270	4
One-Way Self-Amplified	V-2271	4
One-Way 25/70 Volt	V-2273	4

### 2' x 2' Speaker

IP One-Way, SECURE	VIP-402A	8
IP One-Way, SECURE, InformaCast®	VIP-402A-IC	8
IP One-Way, SECURE, IntradoRevolution®	VIP-402A-SA	8
IP One-Way, European Version, InformaCast®	VIP-402A-EC-IC	8
IP Talkback	VIP-422A	8
IP Talkback, InformaCast®	VIP-422A-IC	8
IP Talkback, IntradoRevolution®	VIP-422A-SA	8
One-Way (2 Pack)	V-9022A-2	8
One-Way, European Version	V-9022-EC	8
One-Way, Dual-Input	V-9028	8
Talkback	V-9062	8
25/70 Volt without Volume Control	S-422A-2	8
25/70 Volt with Volume Control	S-522B-2	8

### 1' x 2' Speaker

One-Way	V-9021	8
25/70 Volt with Volume Control	S-521B	8
Accessory: Trim T-Bar (10 Pack)	V-TBAR	8

### 8-Inch Round Speaker

IP One-Way, SECURE	VIP-120A	9
IP One-Way, SECURE, InformaCast®	VIP-120A-IC	9
IP One-Way, SECURE, IntradoRevolution®	VIP-120A-SA	9
IP Talkback	VIP-160A	9
IP Talkback InformaCast®	VIP-160A-IC	9
One-Way, SECURE	V-1020C	9
One-Way Dual-Input	V-1220	9
Talkback	V-1060A	9
25/70 Volt	S-500	9
25/70 Volt with Volume Control	S-500VC	9

#### Accessories for Mounting:

Speaker Bridge (5 Pack)	V-9914M-5	9
Backbox (5 Pack)	V-9915M-5	9
Bridge/Backbox Combo	V-9916M	9
Pre-Construction Mounting Ring (10 Pack)	V-9912M-10	9
Post-Construction Mounting Ring (12 Pack)	V-9912P-12	9

### 4-Inch Round Speaker

One-Way	V-1010C	9
Accessories for Mounting:		
Speaker Bridge (5 Pack)	V-9904M-5	9
Backbox (5 Pack)	V-9915M-5	9

### Square Ceiling (Round Hole Pattern)

One-Way	V-1920C	9
Talkback	V-CTSQPK	9

### Square Ceiling (Square Hole Pattern)

IP One-Way or Talkback Programmable	VIP-428A	9
IP Talkback, InformaCast®	VIP-428A-IC	9
IP Talkback, IntradoRevolution®	VIP-428A-SA	9
One-Way	V-1921	9
Talkback	V-1961	9

#### Accessories for Mounting:

Angled Mount Backbox	VB-A13	9
Recessed Mount Backbox	VB-R12	9
Surface Mount Backbox	VB-S11	9

### P-Tec™ Speaker

One-Way	V-1001	10
---------	--------	----

### Clean Room Speaker

IP One-Way or Talkback Programmable	VIP-140A	10
-------------------------------------	----------	----

Description Part # VPU Pg #

One-Way	V-1040	10
---------	--------	----

### Surface Mount Speaker

One-Way	V-9010-W	10
---------	----------	----

### Pendant

\* Colors: Black -BK, Gray -GY, White -W, Custom Colors -CC

IP One-Way or Talkback Programmable	VIP-415*	10
IP One-Way, InformaCast®	VIP-415-IC*	10
One-Way Black Grill	V-1015B*	10
One-Way White with White Grill	V-1015B-WW*	10
25/70 Volt Black with Black Grill	S-520B-BK	10
25/70 Volt White with Black Grill	S-520B-W	10

#### Accessory:

Additional Six Foot Chain	V-1093-BK	10
---------------------------	-----------	----

## HIGH-FIDELITY SPEAKERS



### Signature Series™ Lay-In Speaker

One-Way	V-1422	11
Accessories: Trim T-Bar (10 Pack)	V-TBAR	11

### Signature Series™ Ceiling Speaker

One-Way	V-1420	11
Accessories: HiFi Bridge & Backbox	V-9816M	11

### Signature Series™ In-Wall Speaker

One-Way	V-1450	11
---------	--------	----

## WALL SPEAKERS



### Slimline™ Speaker

Colors: Black -BK, Gray -GY, White -W		
One-Way	V-1042	12
Accessories: Wire Cage (2 Pack)	V-WGWALL-2	12

### Desktop/Wall Speaker

Colors: Black -BK, Gray -GY, White -W		
One-Way	V-763	12
Talkback	V-762	12
Talkback w/Push Button	V-764	12

### Track-Style Speaker

* Colors: Black -BK, White -W and Custom Colors -CC		
1-Watt One-Way Black Grill	V-1013B*	12
1-Watt One-Way White with White Grill	V-1013B-WW*	12
5-Watt One-Way Black Grill	V-1014B*	12

### Metal Wall Speaker

IP One-Way, InformaCast®	VIP-410A-IC	13
IP One-Way or Talkback Programmable	VIP-430A	13
IP Talkback, InformaCast®	VIP-430A-IC	13
IP Talkback, IntradoRevolution®	VIP-430A-SA	13
One-Way	V-1052C	13
Talkback	V-1071	13
25/70 Volt	S-504	13
Accessories: Wire Guard (2 Pack)	V-WGWALL-2	13

### Metal Corner Speaker

Talkback	V-1055	13
----------	--------	----

### Square Wall Speaker

IP One-Way or Talkback Programmable	VIP-428A	13
IP Talkback, InformaCast®	VIP-428A-IC	13
IP Talkback, IntradoRevolution®	VIP-428A-SA	13
One-Way	V-1921	13
Talkback	V-1961	13

#### Accessories for Mounting:

Angled Mount Backbox	VB-A13	13
Recessed Mount Backbox	VB-R12	13
Surface Mount Backbox	VB-S11	13

### Black Wall Speaker

One-Way	V-1016-BK	14
Talkback	V-1061-BK	14





**White Wall Speaker**

One-Way ..... V-1016-W-1 14

Talkback ..... V-1061-W-0 14

**White Bi-Directional Corridor Speaker**

One-Way ..... V-1026C-W-1 14

**Light Woodgrain Angled Wall Speaker Open-Weave Grille**

One-Way ..... V-1022C-1 14

One-Way, Dual-Input ..... V-1222-1 14

**Light Woodgrain Bi-Directional Corridor Speaker Open-Weave Grille**

One-Way ..... V-1026C-1 14

**Dark Woodgrain Angled Wall Speaker Cloth Grille**

One-Way ..... V-1023C-1 14

Talkback ..... V-1063A-0 14

25/70 Volt ..... S-505 14

25/70 Volt with Volume Control ..... S-505VC 14

**Accessory for Mounting:**

Wire Guard (2 Pack) ..... V-WGWALL-2 14

## VANDAL-RESISTANT SPEAKERS

**Vandal-Resistant Wall Speaker**

One-Way ..... V-9852-1 15

Talkback ..... V-9871-0 15

**Vandal-Resistant FlexHorn™ Surface Mount Unit**

IP One-Way or Talkback Programmable ..... VIP-580A 15

IP One-Way, InformaCast® ..... VIP-580A-IC 15

IP One-Way, IntradoRevolution® ..... VIP-580A-SA 15

One-Way ..... V-9880-3 15

Talkback ..... V-9890-0 15

**Vandal-Resistant FlexHorn™ Angled Surface Mount Unit**

IP One-Way or Talkback Programmable ..... VIP-581A 15

IP One-Way, InformaCast® ..... VIP-581A-IC 15

IP One-Way, IntradoRevolution® ..... VIP-581A-SA 15

**Vandal-Resistant FlexHorn™ Bi-Directional Surface Mount Unit**

One-Way ..... V-9885-6 15

## HIGH-EFFICIENCY HORNS



5-Watt, IP One-Way Beige ..... VIP-130AL-BGE 16

InformaCast® Beige ..... VIP-130AL-BGE-IC 16

IntradoRevolution® Beige ..... VIP-130AL-BGE-SA 16

5-Watt, IP One-Way Gray ..... VIP-130AL-GY 16

InformaCast® Gray ..... VIP-130AL-GY-IC 16

IntradoRevolution® Gray ..... VIP-130AL-GY-SA 16

High Power IP Horn, Talkback Gray PoE+ ..... VIP-142-GY 16

InformaCast® Gray, PoE+ ..... VIP-142-GY-IC 16

IntradoRevolution® Gray, PoE+ ..... VIP-142-GY-SA 16

IP Talkback Beige ..... VIP-148AL-BGE 16

InformaCast® Beige ..... VIP-148AL-BGE-IC 16

IntradoRevolution® Beige ..... VIP-148AL-BGE-SA 16

IP Talkback Gray ..... VIP-148AL-GY 16

InformaCast® Gray ..... VIP-148AL-GY-IC 16

IntradoRevolution® Gray ..... VIP-148AL-GY-SA 16

5-Watt, One-Way Beige ..... V-1030C 16

5-Watt, One-Way Gray ..... V-1030C-GY 16

15-Watt, One-Way Beige ..... V-1036C-15 16

15-Watt, One-Way Gray ..... V-1036C-GY-15 16

15-Watt 25/70 Volt Gray Metal ..... S-615 16

Talkback Beige ..... V-1048C-0 16

Talkback Gray ..... V-1048C-GY-0 16

15-Watt 25/70/100 Volt Beige (for Gray add -GY) ..... SX15-T 16

30-Watt 25/70/100 Volt Beige (for Gray add -GY) ..... SX30-T 16

**Marine Horn White**

IP One-Way ..... VIP-130AL-M 16

IP One-Way, InformaCast® ..... VIP-130AL-M-IC 16

IP One-Way, IntradoRevolution® ..... VIP-130AL-M-SA 16

IP Talkback ..... VIP-148AL-M 16

IP Talkback, InformaCast® ..... VIP-148AL-M-IC 16

IP Talkback, IntradoRevolution® ..... VIP-148AL-M-SA 16

5-Watt, One-Way ..... V-1030M-5 16

15-Watt, One-Way ..... V-1036M-15 16

15-Watt, 25/70 Volt ..... SX15-TM 16

30-Watt, 25/70 Volt ..... SX30-TM 16

Talkback ..... V-1048M-0 16

30-Watt, One-Way Beige \*Use 48VDC Power Supply ..... V-1038\* 16

**Accessories: Wire Guard (2 Pack) ..... V-WGHORN-2 16**

**Bi-Directional Horn**

One-Way Beige ..... V-1050C-6 16

**Explosion-Proof Horn Gray**

One-Way ..... V-1039A-20 16

25/70 Volt ..... S-660A 16

## FLEXHORNS



**StealthHorn (FlexHorn)**

IP One-Way Bronze ..... VIP-9831A 17

IP One-Way White ..... VIP-9831A-W 17

IP One-Way Long Line Extender, Bronze ..... VIP-9831AL 17

IP One-Way Long Line Extender, White ..... VIP-9831AL-W 17

One-Way Bronze ..... V-9830-3 17

One-Way White ..... V-9830-W-3 17

**Stealth Corridor (6-inch Speaker)**

IP One-Way or Talkback Programmable Bronze ..... VIP-9815A 17

IP One-Way, InformaCast® Bronze ..... VIP-9815A-IC 17

One-Way Bronze ..... V-9815-3 17

One-Way White ..... V-9815-W-3 17

**FlexHorn®**

IP One-Way ..... VIP-480AL 17

IP One-Way, InformaCast® ..... VIP-480AL-IC 17

IP One-Way, IntradoRevolution® ..... VIP-480AL-SA 17

One-Way ..... V-1080-3 17

Talkback ..... V-1090-0 17

70 Volt ..... S-604 17

25 Volt ..... S-604-25 17

**Mounting Options:**

Adjustable Mounting Bracket Included with FlexHorn ..... V-9804 17

Wire Guard (2 Pack) ..... V-WGFLEX-2 17

**Make FlexHorns Vandal-Resistant:**

Stainless Steel Enclosure & Faceplate ..... V-9805 17

Stainless Steel Faceplate ..... V-9806 17

Heavy Gauge Steel Enclosure & Faceplate ..... V-9809 17

**IP Square Surface Mount FlexHorn™**

IP One-Way or Talkback Programmable ..... VIP-9880A 17

IP One-Way, InformaCast® ..... VIP-9880A-IC 17

IP One-Way, IntradoRevolution® ..... VIP-9880A-SA 17

**Accessory for Mounting:**

Recessed Mount Backbox ..... VB-R17-D 17

## SIP PAGING



1 Zone Analog/Plus 8 Zones SIP Station/100 Zone SIP TrunkVIP-201A ... 18

4 Zone Analog/Plus 8 Zones SIP Station/100 Zone SIP TrunkVIP-204B ... 18

IP Network Input/Output Module, InformaCast® ..... VIP-848AR-IC 18

SIP 20W Gateway 25V ..... VIP-851-25 18

SIP 20W Gateway 25V, InformaCast® ..... VIP-851-25-IC 18

SIP 20W Gateway 25V/70/100V ..... VIP-851-70/100 18

SIP 20W Gateway 25V/70/100V, InformaCast® ..... VIP-851-70/100-IC 18

Description

Part # VPU Pg #

Description

Part # VPU Pg #



**Audio Ports** (Line Level -10dbm)

1 Audio Port	VIP-801A	19
1 Audio Port, InformaCast®	VIP-801A-IC	19
1 Audio Port, IntradoRevolution®	VIP-801A-SA	19
2 Audio Ports	VIP-802B	19
4 Audio Ports	VIP-804B	19

**FXS Ports** (Station Ports)

1 FXS Port	VIP-811A	19
2 FXS Ports	VIP-812B	19
4 FXS Ports	VIP-814B	19

**FXO Ports** (Loop Start)

1 FXO Port	VIP-821A	19
2 FXO Ports	VIP-822A	19
4 FXO Ports	VIP-824A	19

**ACS Speakers**

8-Inch Round Ceiling Speaker Talkback	V-C806PK	23
8-Inch Round Ceiling Speaker Talkback	VC-1060A	23
8-Inch Square Ceiling Speaker Talkback	V-CTSQPK	23
2' x 2' Lay-In Ceiling Speaker Talkback	VC-9062	23
2' x 2' Lay-In Ceiling Speaker Talkback (2 Pack)	V-CTLA-2	23
Optional Trim Bar Use to Install in a 2 x 4 Ceiling Tile (10 Pack)	V-TBAR	23
Metal Wall Speaker Talkback	V-WTGY	23
Black Wall Speaker Talkback	VC-1061-BK	23
White Wall Speaker Talkback	VC-1061-W	23
Woodgrain Wall Speaker Talkback	VC-1062A	23
FlexHorn™ Talkback	VC-1090	23

**ACS Accessories:**

One-Way Paging Adapter	V-LPT	23
Clock Control Interface Package	V-CLK	23
Large LED Display Package	V-DSP	23
Serial/Clock Driver Card	V-SER	23
Clock Relay Card	V-CIO	23

Backplane Cable 4 Position Feature Cards	VC40R-4	23
Backplane Cable/Terminator 8 Position Feature Cards	VC40R-8T	23
Backplane Cable/Terminator 9 Position Feature Cards	VC40R-9T	23
Backplane Cable/Terminator 16 Position Feature Cards	VC40R-16T	23

**ACS Call-In Button**

Emergency/Normal - Stainless Steel	V-2970	23
Rocker Push Button - Stainless Steel	V-2972	23
Rocker Push Button - Stainless Steel (6 Pack)	V-2972PK	23

**ACS Power Supply**

6 Amp Positive 24 Vdc - Wall Mount	V-C6124P	23
------------------------------------	----------	----

**PAGE CONTROLS**



Universal Paging Interface	V-9972	6, 20
Universal Paging Interface with Licenses	V-9972-2	6, 20
License Extended Functions	L9972-1	6, 20
License Gateway Functions	L9972-2	6, 20
RingCentral® Paging Adapter	VRCPA	20

**Analog 2000 Series**

<b>1 Zone</b>		
One-Way	V-2000A	21
<b>1 Zone Enhanced</b>		
One-Way	V-2001A	21
One-Way European Version	V-2001A-E	21
<b>3 Zones</b>		
One-Way	V-2003A	21
One-Way European Version	V-2003A-E	21
Talkback	V-2003AHF	21
<b>6 Zones</b>		
One-Way	V-2006A	21
One-Way European Version	V-2006A-E	21
Talkback	V-2006AHF	21

**Analog Page Controls**

<b>1 Zone</b> ♦ PBX Loop Start Trunk, Electronic Key Line, Single Line Phone		
Talkback	V-9941A	21
<b>1 Zone</b> ● Station Level/FXS Adapters		
Talkback	V-9940	21

**ADVANCED COMMUNICATION SYSTEMS**

**24 - 72 Zones**



**ACS**

25-Volt	V-ACS25	22
Expands the V-ACS25 to 48-Zone	V-ACS-X48/25	22
Expands the V-ACS25 to 72-Zone	V-ACS-X72/25	22
45-Ohm	V-ACS45	22
Expands the V-ACS45 to 48-Zone	V-ACS-X48/45	22
Expands the V-ACS45 to 72-Zone	V-ACS-X72/45	22
<b>Accessories:</b>		
24 Station Cable Adapter for Transition from V-2924A to V-ACS	V-CA2924	22

**INTERCOM/DOOR ENTRY**



**SIP Doorplate Speakers Vandal-Resistant**

SIP Talkback Stainless Steel	VIP-176A	24
SIP Talkback InformaCast® Stainless Steel	VIP-176A-IC	24
Optional Smart Relay for Door Strikes & Gate Openers	VM-SRLY	24

**SIP Intercoms with Long Line Extender**

IP Talkback w/LED Stainless Steel	VIP-172AL-VRSS	24
IP Talkback w/LED, InformaCast® Stainless Steel	VIP-172AL-VRSS-IC	24
IP Talkback w/LED, IntradoRev.® Stainless Steel	VIP-172AL-VRSS-SA	24
IP Talkback w/LED, Stainless Steel	VIP-172AL-ST	24
IP Talkback w/LED, InformaCast® Stainless Steel	VIP-172AL-ST-IC	24

**Doorplate Speakers**

Vandal-Resistant Talkback White	V-1073	24
Talkback Stainless Steel	V-1072A-ST	24
Talkback w/LED Stainless Steel	V-1072B-ST	24

**Accessories:**

Doorbox Weather Guard, Black	V-9910-BK	24
Doorbox Weather Guard, Yellow	V-9910-YEL	24
Surface Mount Talkback, Gray Plastic	V-1074	24

**Door Answering/Unlock Devices**

Single Door Answer & Unlock Control	V-2901A	24
Four Door Answer & Unlock Control	V-2904	24
Single Door Answering Control	V-2900	24

Description

Part # VPU Pg #

## POWER SUPPLIES



300mA/24V	VP-324D	+6	25
600mA/24V	VP-624D	+12	25
1 Amp/24V	VP-1124D	+20	25
2 Amp/24V	VP-2124D	+40	25
2 Amp/48V <i>For the V-1038, 30-Watt Horn, page 16</i>	VP-2148D	N/A	25
4 Amp/24V	VP-4124D	+60	25
6 Amp/24V <i>Negative output with common positive</i>	VP-6124	+120	25
6 Amp/24V <i>Positive output with common negative</i>	VP-6124-P	+120	25
<b>Accessory:</b>			
Power Supply Shelf <i>Holds Two VP-6124 Power Supplies</i>	VP-9202	N/A	25
12 Amp/24V	VP-12124	+240	25
Battery Back-Up Power	VPB-260	N/A	25
Battery Back-Up Charger	VP-6124-UPS	0	25
Battery Box with Batteries	VBB-1424	0	25
400mA/12V <i>Unfiltered</i>	VP-412A	N/A	25
IP 24VDC, 300mA	VIP-324D		25

## ACCESSORIES



### Call Buttons

Normal w/Volume Control <i>Stainless Steel</i>	V-2971	0	26
Normal w/Volume Control <i>White</i>	V-2991-W	0	26
Emergency/Normal w/Volume Control, <i>Stainless Steel</i>	V-2970	0	26
Emergency/Normal w/Volume Control, <i>White</i>	V-2995-W	0	26
w/Privacy Switch w/Volume Control, <i>Stainless Steel</i>	V-9320	0	26
w/Braille w/Volume Control <i>Stainless Steel</i>	V-2977	0	26
Rocker Push Button w/o Volume Control, <i>Stainless Steel</i>	V-2972	0	26
Rocker Push Button w/o Vol Control, <i>Stainless Steel, (6 Pk)</i>	V-2972PK	0	26
Emergency <i>Vandal-Resistant, w/o Volume Control, Red</i>	V-2976	0	26



### Speaker Volume Controls

Speaker Volume Control <i>w/ Single Gang Box, Stainless Steel</i>	V-1092	0	26
Speaker Volume Control <i>w/o Single Gang Box, Stainless Steel</i>	V-1092B	0	26
25/70 Volt Volume Control <i>w/o Single Gang Box, Stainless Steel, S-560</i>	S-560	0	26
Speaker Volume Control <i>w/o Single Gang Box, White</i>	V-2992-W	0	26
Speaker Volume Control <i>w/Slide Switch w/o Single Gang Box, SS</i>	V-1097	0	26
3RU Rack Mount Volume Control Panel <i>Black, Gray</i>	V-VCPANEL	0	26

Spot SoundMasking™ Speaker 2' x 2' Lay-In Ceiling... V-9422... N/A... 27

### Volume Control Sensors

Noise Sensing Volume Control	V-9933A	2	27
Remote Microphone	V-9934	N/A	27

### Microphone Panel with Stored Messages

Stored Message/Mic Page Panel	V-9908	5	28
-------------------------------	--------	---	----

Description

Part # VPU Pg #

## Dynamic Microphones



Desk Paging Microphone	V-400	0	28
25/70 Volt Desk Paging Microphone	SBS-400		28
Handheld Microphone	V-420	0	28
Gooseneck Microphone	V-450	0	28
25/70 Gooseneck Microphone	SDO-450		28
Microphone Adapter	V-9939C	1	28
Audio Interface	V-1096	0	28
Screw Terminal Block	VM-150		28

## Line Transformers & 70 Volt Expander



Input Line Matching Transformer	VMT-1	N/A	29
Audio Isolation Transformer	VMT-2	N/A	29
70 Volt Expander <i>Stainless Steel</i>	V-1095	0	29

## Paging Expansion



Page Port PreAmp/Expander <i>w/ Single Gang Box, Stainless Steel</i>	V-1094A	1	29
Page Port PreAmp/Expander <i>w/o Single Gang Box, Stainless Steel</i>	V-1094B	1	29
Page Port PreAmp/Expander <i>w/o Single Gang Box, White</i>	V-2994-W	1	29

## Mixers



2 Channel In-Wall Mixer <i>White</i>	V-9983-W	1	30
4 Channel In-Wall Mixer <i>White</i>	V-9985-W	1	30
In-Wall Remote Module <i>White</i>	V-9984-W	1	30

## Amplifiers



120-Watt Amplifier	SM120		30
Remote Volume Control <i>for SM120</i>	SM-VC		30

## 25/70 Volt Amplifiers

15-Watt Wall Mount Mixer Amplifiers	SWM-15		30
35-Watt Wall Mount Mixer Amplifiers	SWM-35A		30

Remote Input Module *White*... V-9130-W... 30

6 Channel Amplifier (70 Volt)... V-6120... 0... 30

## Eliminate Feedback/Background Music



Stacking Feedback Eliminator	V-9964	6	31
USB Multi-Messenger Device	V-9989	0	31
USB Message-On-Hold Device	V-9988	0	31

## Audible Alertings — Ringer Horns



Loud Warble Ringer Horn	V-9925A	10	32
Single Tone Warble Horn <i>Power Included</i>	V-9945A		32

## Add Tones Over Paging



Multi-Tone Generator	V-9927A	2	32
6 Line C.O. Audible Ring Unit	V-9936A	4	32
1 Line C.O. Audible Ring Unit	V-9924C	6	32



Description Part # VPU Pg #



**Visual Alerting – Strobes**

<b>IP Strobe, Exterior</b> Blue -BL, Red -RD, Green -GN.....	VIP-997.....	32
<i>InformaCast®</i> Blue -BL, Red -RD, Green -GN.....	VIP-997-color-IC.....	32
<i>IntradoRevolution®</i> Blue -BL, Red -RD, Green -GN	VIP-997-color-SA.....	32
<b>IP Strobe</b> Amber -AM, Blue -BL, Green -GN, Red -RD, White -WH	VIP-998-color.....	32
<i>InformaCast®</i> same colors as above.....	VIP-998-color-IC.....	32
<i>IntradoRevolution®</i> same colors as above.....	VIP-998-color-SA.....	32
<b>Strobe</b> Amber -AM, Blue -BL, Green -GN, Red -RD, White -WH	V-998-AM-color.....	32



<b>Auxiliary Relay Unit</b> .....	V-9955.....	32
<b>Threat Level Indicator</b> .....	VIP-996.....	32

**IP Interactive Console**



<b>IP Interactive Console</b> .....	VIP-893.....	5, 33
<b>IP Interactive Console with Scheduling</b> .....	VIP-893S.....	5, 33
<b>Scheduler Firmware Upgrade</b> for customers with VIP-893.....	L893-S.....	5, 33
<b>IP Building Communication Panel with Scheduling</b> .....	VIP-895-S.....	5, 33
<b>IP Emergency Communication Panel</b> .....	VIP-895-E.....	5, 33

**IP PoE LED Scrolling Message Signs**



<b>20-Inch Wide</b>		
<b>IP Speaker-with-Text and Flashers, Black</b> .....	VL520BK-F-FC.....	33
<i>InformaCast®</i> .....	VL520BK-F-FC-IC.....	33
<i>IntradoRevolution®</i> .....	VL520BK-F-FC-SA.....	33
<b>IP Speaker-with-Text and Flashers, Metallic</b> .....	VL520M-F-FC.....	33
<i>InformaCast®</i> .....	VL520M-F-FC-IC.....	33
<i>IntradoRevolution®</i> .....	VL520M-F-FC-SA.....	33

<b>Wire Guard</b> for VL-520 (2 Pack).....	V-WGVL520-2.....	33
--	------------------	----

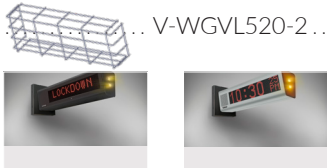

<b>20-Inch Wide, Double-Sided</b>		
<b>IP Speaker-with-Text and Flashers, Black</b> .....	VL522BK-F-FC.....	33
<i>InformaCast®</i> .....	VL522BK-F-FC-IC.....	33
<i>IntradoRevolution®</i> .....	VL522BK-F-FC-SA.....	33
<b>IP Speaker-with-Text and Flashers, Metallic</b> .....	VL522M-F-FC.....	33
<i>InformaCast®</i> .....	VL522M-F-FC-IC.....	33
<i>IntradoRevolution®</i> .....	VL522M-F-FC-SA.....	33

<b>IP Speaker-with-Text and Flashers Black</b> .....	VL550F-FC.....	33
<i>InformaCast®</i> .....	VL550F-FC-IC.....	33
<i>IntradoRevolution®</i> .....	VL550F-FC-SA.....	33
<b>IP Speaker-with-Text and Flashers, Metallic</b> .....	VL550M-F.....	33
<i>InformaCast®</i> .....	VL550M-F-FC-IC.....	33
<i>IntradoRevolution®</i> .....	VL550M-F-FC-SA.....	33

<b>Wire Guard</b> for VL-550 (2 Pack).....	V-WGVL550-2.....	33
--	------------------	----

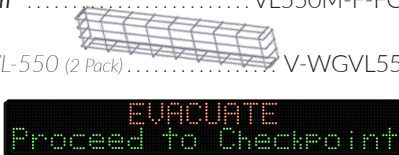

<b>80-Inch Wide</b>		
<b>IP PoE Outdoor LED Sign Black</b> .....	VL590-RG.....	33
<i>InformaCast®</i> .....	VL590-RG-IC.....	33
<i>IntradoRevolution®</i> .....	VL590-RG-SA.....	33

<b>Threat Level Indicator, Add-On</b> .....	VL-TL3.....	32
---	-------------	----

Does not work with the InformaCast® and IntradoRevolution® Versions



Description Part # VPU Pg #

**EMERGENCY HELP POINTS**



Available in Multiple Styles and/or Colors - Contact Valcom 1.800.825.2661

<b>Tower Emergency Telephone</b> .....	VE9811.....	34
<i>InformaCast®</i> .....	VE9811-IC.....	34

<b>Emergency Call Station</b> .....	VIP-9895.....	35
<i>InformaCast®</i> .....	VIP-9895-IC.....	35

<b>Multi-Button Call Station</b> .....	VIP-9894.....	35
<i>InformaCast®</i> .....	VIP-9894-IC.....	35

<b>Vandal-Resistant Emergency Call Station</b>		
<b>IP Call Station</b> .....	VIP-9890A-EM.....	35
<i>InformaCast®</i> .....	VIP-9890A-EM-IC.....	35
<b>IP Call Station Long Line Extender</b> .....	VIP-9890AL-EM.....	35
<i>InformaCast® Long Line Extender</i> .....	VIP-9890AL-EM-IC.....	35

<b>Vandal-Resistant Call Station</b>		
<b>IP Intercom/Doorphones Long Line Extender</b> .....	VIP-9890AL-CB.....	35
<i>InformaCast® Long Line Extender</i> .....	VIP-9890AL-CB-IC.....	35

<b>IP Repurpose Emergency Call Plate</b> .....	VE9870A.....	35
--	--------------	----

**CLOCKS**



<b>IP PoE Clocks</b>		
<b>12-Inch Analog</b> .....	VIP-A12A.....	36
<b>16-Inch Analog</b> .....	VIP-A16A.....	36
<b>12-Inch Analog Double-Sided</b> .....	VIP-A12ADS.....	36
<b>16-Inch Analog Double-Sided</b> .....	VIP-A16ADS.....	36

<b>4-Digit 2.5-Inch #'s Digital</b> .....	VIP-D425A.....	36
<b>4-Digit 4.0-Inch #'s Digital</b> .....	VIP-D440A.....	36
<b>4-Digit 2.5-Inch #'s Digital Double-Sided</b> .....	VIP-D425ADS.....	36
<b>4-Digit 4.0-Inch #'s Digital Double-Sided</b> .....	VIP-D440ADS.....	36

<b>6-Digit 2.5-Inch #'s Digital</b> .....	VIP-D625A.....	36
<b>6-Digit 4.0-Inch #'s Digital</b> .....	VIP-D640A.....	36
<b>6-Digit 2.5-Inch #'s Digital Double-Sided</b> .....	VIP-D625ADS.....	36
<b>6-Digit 4.0-Inch #'s Digital Double-Sided</b> .....	VIP-D640ADS.....	36

<b>Wireless Clocks</b>		
<b>12-Inch Analog, Battery Operated</b> .....	V-AW12B.....	37
<b>12-Inch Analog, Military Dial</b> .....	V-AW12B-MD.....	37
<b>12-Inch Analog, 110Vac/24Vdc</b> .....	V-AW12BLP.....	37
<b>16-Inch Analog, Battery Operated</b> .....	V-AW16B.....	37
<b>16-Inch Analog, 110Vac/24Vdc</b> .....	V-AW16BLP.....	37
<b>4-Digit 2.5-Inch #'s Digital</b> .....	V-DW11025B.....	37
<b>4-Digit 4.0-Inch #'s Digital</b> .....	V-DW11040B.....	37

<b>Wired Clocks</b>		
<b>12-Inch Analog, 24Vdc</b> .....	V-A2412B.....	37
<b>12-Inch Analog, 110Vac</b> .....	V-A11012B.....	37
<b>16-Inch Analog, 24Vdc</b> .....	V-A2416B.....	37
<b>16-Inch Analog, 110Vac</b> .....	V-A11016B.....	37
<b>4-Digit 2.5-Inch Numbers Digital 24Vdc</b> .....	V-D2425B.....	37
<b>4-Digit 4.0-Inch Numbers Digital 24Vdc</b> .....	V-D2440B.....	37

Description Part # VPU Pg #



**Analog Accessories**

<b>Wireless Double-Sided Brackets</b>		
12-Inch Clocks	V-WDM12	38
16-Inch Clocks	V-WDM16	38
<b>Wired Double-Sided Brackets</b>		
12-Inch Clocks	V-BDM12-S	38
16-Inch Clocks	V-BDM16-S	38
<b>Surface Mounting for Wired Clocks</b>		
12-Inch Clocks	V-SMR12A	38
16-Inch Clocks	V-SMR16A	38
<b>Surface Mounting for Wireless Clocks</b>		
12-Inch Clocks	V-SMR12AW	38
16-Inch Clocks	V-SMR16AW	38
<b>Wire Guards for 12 &amp; 16" Analog Clocks</b>	V-WGACLK	38
<b>Digital Accessories:</b>		
<b>Double-Sided Brackets 4-Inch Digital Clock</b>	V-DMKIT	38
<b>Wire Guard for 4-Inch Digital Clock</b>	V-WGD4	38



**Clock Controls & Drivers**

<b>IP Master Clock</b>	VIP-MC	38
<b>Wireless Master Clock Transceiver</b>	V-WMCA	38
<b>Wireless Master Clock Repeater</b>	V-WMCRA	38
<b>Digital Clock Protocol Interface</b>	V-DCPI	38
<b>Clock Interface Controller Kit</b>	V-VCU	38
<b>GPS Master Clock</b>		
Wireless	V-GPS-TX	38
Wired	V-GPSA	38
<b>Digital Clock Head End Driver, 2-Wire</b>	V-DCH	38

**IP Clock/Speaker Combos**



**Flush Mount - Analog White**

<b>IP One-Way or Talkback Programmable</b>	VIP-429A-A	39
<b>IP Talkback, InformaCast®</b>	VIP-429A-A-IC	39
<b>IP Talkback, IntradoRevolution®</b>	VIP-429A-A-SA	39
<b>IP Talkback, InformaCast® Larger</b>	VIP-431A-A-IC	39

**Flush Mount - Digital White**

<b>6-Digits One-Way or Talkback Programmable</b>	VIP-426A-D	39
<b>4-Digits One-Way or Talkback Programmable</b>	VIP-429A-D	39
<b>4-Digits IP Talkback, InformaCast®</b>	VIP-429A-D-IC	39
<b>4-Digits IP Talkback, IntradoRevolution®</b>	VIP-429A-D-SA	39

**Backboxes**

<b>Angled Mount</b>	VB-A24	39
<b>Recessed Mount</b>	VB-R22	39
<b>Surface Mount</b>	VB-S23	39

**Flush Mount - Digital Gray**

<b>IP One-Way or Talkback Programmable</b>	VIP-432A-DF	39
<b>IP One-Way, InformaCast®</b>	VIP-432A-DF-IC	39
<b>Backboxes</b>		
<b>Angled Mount</b>	VB-A21	39
<b>Recessed Mount</b>	VB-R19	39
<b>Surface Mount</b>	VB-S20	39

Description Part # VPU Pg #

**Angled Surface Mount - Digital Gray**

<b>IP One-Way or Talkback Programmable</b>	VIP-431A-DS	39
<b>IP One-Way, InformaCast®</b>	VIP-411A-DS-IC	39
<b>IP Talkback, InformaCast®</b>	VIP-431A-DS-IC	39
<b>IP Talkback, IntradoRevolution®</b>	VIP-431A-DS-SA	39

**IP Speaker Clock Kits**

50ft pre-terminated cable included

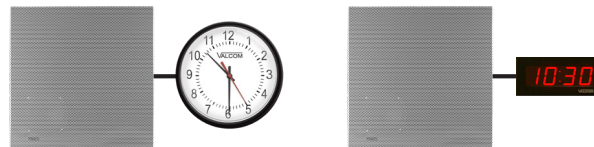

**2'x2' Lay-In Ceiling Spkr+Analog Clock, InformaCast®** . . . VIP-4122-A12-IC . . . 40

**2'x2' Lay-In Ceiling Spkr+Digital Clock, InformaCast®** . . . VIP-4122-D44-IC . . . 40



**Metal Wall Spkr+Analog Clock, InformaCast®** . . . VIP-4171-A12-IC . . . 40

**Metal Wall Spkr+Digital Clock, InformaCast®** . . . VIP-4171-D44-IC . . . 40

**Speakers & Clock Speaker Assemblies**

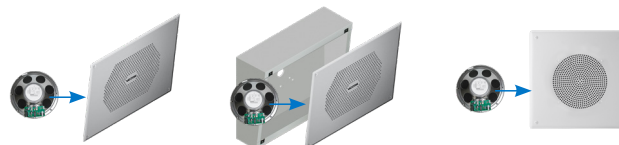

**Speaker Assembly Faceplates**

**Vandal-Resistant**

<b>Faceplate Gray, -CC</b>	V-9808	41
<b>Faceplate &amp; Enclosure Gray, -CC</b>	V-9807	41
<b>Square Grille (Round Hole Pattern) White</b>	V-936480	41
<b>Backboxes for V-936480</b>		
<b>Angled</b>	VB-A13	41
<b>Recessed</b>	VB-R12	41
<b>Surface</b>	VB-S11	41

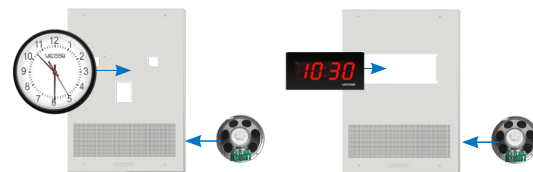

**Clock/Speaker Assembly Faceplates**

<b>Analog Faceplate for 12-Inch Clock &amp; 8-Inch Speaker</b>	V-CSB12S	41
<b>Digital Faceplate for 2.5-Inch Clock &amp; 8-Inch Speaker</b>	V-CSB25	41
<b>Backboxes for Clock/Speakers Faceplates</b>		
<b>Angled</b>	VB-A21	41
<b>Recessed</b>	VB-R19	41
<b>Surface</b>	VB-S20	41

**8-Inch Speaker Assemblies**

<b>24V Speaker</b>	VSA-1020C	1	41
<b>45 Ohm Speaker</b>	V-936418	0	41
<b>25/70 Volt Speaker</b>	V-936400	0	41

# Numerical Index

Part #	Page #	Part #	Page #	Part #	Page #	Part #	Page #
L893-S	5, 31	V-1038	16	V-2972PK	23, 26	V-9945A	32
L9972-1	6, 20	V-1039A	16	V-2976	26	V-9955	32
L9972-2	6, 20	V-1040	10	V-2977	26	V-9964	31
S-422A-2	8	V-1042 -BK, -GY, -W	12	V-2991-W	26	V-9972	6, 20
S-521B	8	V-1048C	16	V-2992-W	26	V-9972-2	6, 20
S-522B-2	8	V-1048C-GY	16	V-2994-W	29	V-998 5 colors	32
S-500	9	V-1048M	16	V-2995-W	26	V-9983-W	30
S-500VC	9	V-1050C	16	V-6120	30	V-9984-W	30
S-504	13	V-1052C -CC	13	V-9010-W -CC	10	V-9985-W	30
S-505	14	V-1055 -CC	13	V-9021 -CC	8	V-9988	31
S-505VC	14	V-1060A -CC	9	V-9022A-2 -CC	8	V-9989	31
S-520B-BK	10	V-1061-BK	14	V-9022-EC -CC	8	V-A11012B	37
S-520B-W	10	V-1061-W	14	V-9028 -CC	8	V-A11016B	37
S-560	26	V-1063A	14	V-9062 -CC	8	V-A2412B	37
S-604	17	V-1071 -CC	13	V-9130-W	30	V-A2416B	37
S-604-25	17	V-1072A-ST	24	V-9320	26	V-ACS25	22
S-615	16	V-1072B-ST	24	V-936400	41	V-ACS45	22
S-660A	16	V-1073	24	V-936418	41	V-ACS-X48/25	22
SBS-400	28	V-1074	24	V-936480	41	V-ACS-X48/45	22
SDO-450	28	V-1080 -BGE, -GY, -W	17	V-9422 -CC	27	V-ACS-X72/25	22
SM120	30	V-1090 -BGE, -GY, -W	17	V-9804	17	V-ACS-X72/45	22
SM-VC	30	V-1092	26	V-9805	17	V-AW12B	37
SWM-15	30	V-1092B	26	V-9806	17	V-AW12B-MD	37
SWM-35A	30	V-1093-BK	10	V-9807	41	V-AW12BLP	37
SX15-T	16	V-1094A	29	V-9808	41	V-AW16B	37
SX30-T	16	V-1094B	29	V-9809	17	V-AW16BLP	37
SX15-TM	16	V-1095	29	V-9815 -CC	17	V-BDM12-S	38
SX30-TM	16	V-1096	28	V-9815-W	17	V-BDM16-S	38
V-400	28	V-1097	26	V-9816M	11	V-C6124P	23
V-420	28	V-1220 -CC	9	V-9830 -CC	17	V-C806PK -CC	23
V-450	28	V-1222	14	V-9830-W -CC	17	V-CA2924	22
V-762 -BK, -GY, -W	12	V-1420 -CC	11	V-9852 -CC	15	V-CIO	23
V-763 -BK, -GY, -W	12	V-1422 -CC	11	V-9871 -CC	15	V-CLK	23
V-764 -BK, -GY, -W	12	V-1450 -CC	11	V-9880 -CC	15	V-CSB12S	41
V-1001	10	V-1920C -CC	9	V-9885 -CC	15	V-CSB25	41
V-1010C -CC	9	V-1921 -CC	9, 13	V-9890 -CC	15	V-CTLA-2 -CC	23
V-1013B -BK, -W, -CC	12	V-1961 -CC	9, 13	V-9904M-5	9	V-CTSQPK -CC	9, 23
V-1013B-WW	12	V-2000A	21	V-9908	28	V-D2425B	37
V-1014B -BK, -W, -CC	12	V-2001A	21	V-9910-BK	24	V-D2440B	37
V-1015B -BK, -GY, -W, -CC	10	V-2001A-E	21	V-9910-YEL	24	V-DCH	38
V-1015B-WW	10	V-2003A	21	V-9912M-10	9	V-DCPI	38
V-1016-BK	14	V-2003A-E	21	V-9912P-12	9	V-DMKIT	38
V-1016-W	14	V-2003AHF	21	V-9914M-5	9, 36	V-DSP	23
V-1020C -CC	9	V-2006A	21	V-9915M-5	9	V-DW11025B	37
V-1022C	14	V-2006A-E	21	V-9916M	9	V-DW11040B	37
V-1023C	14	V-2006AHF	21	V-9924C	32	V-GPS-TX	38
V-1026C	14	V-2271	4	V-9925A	32	V-GPSA	38
V-1026C-W	14	V-2273	4	V-9927A	32	V-LPT	23
V-1030C	16	V-2900	24	V-9933A	27	V-SER	23
V-1030C-GY	16	V-2901A	24	V-9934	27	V-SMR12A	38
V-1030M	16	V-2904	24	V-9936A	32	V-SMR12AW	38
V-1036C	16	V-2970	23, 26	V-9939C	28	V-SMR16A	38
V-1036C-GY	16	V-2971	26	V-9940	21	V-SMR16AW	38
V-1036M	16	V-2972	23, 26	V-9941A	21	V-TBAR	8, 11, 23



Part #	Page #	Part #	Page #	Part #	Page #	Part #	Page #
V-VCU	38	VIP-148AL-BGE-IC	16	VIP-480AL -BGE,-GY,-W	17	VIP-A12A	36
V-VCPANEL -BK,-GY	26	VIP-148AL-BGE-SA	16	VIP-480AL-IC -BGE,-GY,-W	17	VIP-A12ADS	36
V-WDM12	38	VIP-148AL-GY	16	VIP-480AL-SA -BGE,-GY,-W	17	VIP-A16A	36
V-WDM16	38	VIP-148AL-GY-IC	16	VIP-580A -CC	15	VIP-A16ADS	36
V-WGACLK	38	VIP-148AL-GY-SA	16	VIP-580A-IC -CC	15	VIP-D425A	36
V-WGD4	38	VIP-148AL-M	16	VIP-580A-SA -CC	15	VIP-D425ADS	36
V-WGFLEX-2	17	VIP-148AL-M-IC	16	VIP-581A -CC	15	VIP-D440A	36
V-WGHORN-2	16	VIP-148AL-M-SA	16	VIP-581A-IC -CC	15	VIP-D440ADS	36
V-WGVL520-2	33	VIP-160A -CC	9	VIP-581A-SA -CC	15	VIP-D625A	36
V-WGVL550-2	33	VIP-160A-IC -CC	9	VIP-801A	19	VIP-D625ADS	36
V-WGWALL-2	12,13,14	VIP-172AL-ST	24	VIP-801A-IC	19	VIP-D640A	36
V-WMCA	38	VIP-172AL-ST-IC	24	VIP-801A-SA	19	VIP-D640ADS	36
V-WMCRA	38	VIP-172AL-VRSS	24	VIP-802B	19	VIP-MC	38
V-WTGY -CC	23	VIP-172AL-VRSS-IC	24	VIP-804B	19	VL-TL3	32
VB-A13	9, 13, 41	VIP-172AL-VRSS-SA	24	VIP-811A	19	VL520BK-F-FC	33
VB-A21	39, 41	VIP-176A	24	VIP-812B	19	VL520BK-F-FC-IC	33
VB-A24	39	VIP-176A-IC	24	VIP-814B	19	VL520BK-F-FC-SA	33
VB-R12	9, 13, 41	VIP-201A	18	VIP-821A	19	VL520M-F-FC	33
VB-R17-D	17	VIP-204B	18	VIP-822A	19	VL520M-F-FC-IC	33
VB-R19	39, 41	VIP-2270	4	VIP-824A	19	VL520M-F-FC-SA	33
VB-R22	39	VIP-324D	25	VIP-848AR-IC	18	VL522BK-F-FC	33
VB-S11	9, 13, 41	VIP-402A -CC	8	VIP-851-25	18	VL522BK-F-FC-IC	33
VB-S20	39, 41	VIP-402A-IC -CC	8	VIP-851-25-IC	18	VL522BK-F-FC-SA	33
VB-S23	39	VIP-402A-SA -CC	8	VIP-851-70/100	18	VL522M-F-FC	33
VBB-1424	25	VIP-402A-EC-IC-CC	8	VIP-851-70/100-IC	18	VL522M-F-FC-IC	33
VC-1060A -CC	23	VIP-410A-IC -CC	13	VIP-893	5, 33	VL522M-F-FC-SA	33
VC-1061-BK	23	VIP-411A-DS-IC	39	VIP-893S	5, 33	VL550BK-F-FC	33
VC-1061-W	23	VIP-415 -BK,-GY,-W	10	VIP-895-S	5, 33	VL550BK-F-FC-IC	33
VC-1062A	23	VIP-415-IC -BK,-GY,-W	10	VIP-895-E	5, 33	VL550BK-F-FC-SA	33
VC-1090 -BGE,-GY,-W	23	VIP-4122-A12-IC	40	VIP-9815A -CC	17	VL550M-F-FC	33
VC-9062 -CC	23	VIP-4122-D44-IC	40	VIP-9815A-IC -CC	17	VL550M-F-FC-IC	33
VC40R-4	23	VIP-4171-A12-IC	40	VIP-9831A -CC	17	VL550M-F-FC-SA	33
VC40R-8T	23	VIP-4171-D44-IC	40	VIP-9831A-W	17	VL590-RG BK	33
VC40R-9T	23	VIP-422A	8	VIP-9831AL -CC	17	VL590-RG-IC BK	33
VC40R-16T	23	VIP-422A-IC	8	VIP-9831AL-W	17	VL590-RG-SA BK	33
VE9811	34	VIP-422A-SA	8	VIP-9880A -CC	17	VM-SRLY	24
VE9811-IC	34	VIP-426A-D -CC	39	VIP-9880A-IC -CC	17	VM-150	28
VE9870A	35	VIP-428A -CC	9, 13	VIP-9880A-SA -CC	17	VMT-1	29
VIP-120A -CC	9	VIP-428A-IC -CC	9, 13	VIP-9890A-EM	35	VMT-2	29
VIP-120A-IC -CC	9	VIP-428A-SA -CC	9, 13	VIP-9890A-EM-IC	35	VP-1124D	25
VIP-120A-SA -CC	9	VIP-429A-A -CC	39	VIP-9890AL-CB	35	VP-12124	25
VIP-130AL-BGE	16	VIP-429A-A-IC -CC	39	VIP-9890AL-CB-IC	35	VP-2124D	25
VIP-130AL-BGE-IC	16	VIP-429A-A-SA -CC	39	VIP-9890AL-EM	35	VP-2148D	25
VIP-130AL-BGE-SA	16	VIP-429A-D -CC	39	VIP-9890AL-EM-IC	35	VP-324D	25
VIP-130AL-GY	16	VIP-429A-D-IC -CC	39	VIP-9894	35	VP-412A	25
VIP-130AL-GY-IC	16	VIP-429A-D-SA -CC	39	VIP-9894-IC	35	VP-4124D	25
VIP-130AL-GY-SA	16	VIP-430A -CC	13	VIP-9895	35	VP-6124	25
VIP-130AL-M	16	VIP-430A-IC -CC	13	VIP-9895-IC	35	VP-6124-P	25
VIP-130AL-M-IC	16	VIP-430A-SA -CC	13	VIP-996	32	VP-6124-UPS	25
VIP-130AL-M-SA	16	VIP-431A-A-IC -CC	39	VIP-997 -BL,-RD,-GN	32	VP-624D	25
VIP-140A -CC	10	VIP-431A-DS -CC	39	VIP-997 -BL,-RD,-GN -IC	32	VP-9202	25
VIP-142-GY	16	VIP-431A-DS-IC -CC	39	VIP-997 -BL,-RD,-GN -SA	32	VPB-260	25
VIP-142-GY-IC	16	VIP-431A-DS-SA -CC	39	VIP-998 5 colors	32	VRCPA	20
VIP-142-GY-SA	16	VIP-432A-DF -CC	39	VIP-998 5 colors -IC	32	VSA-1020C	41
VIP-148AL-BGE	16	VIP-432A-DF-IC -CC	39	VIP-998 5 colors -SA	32		

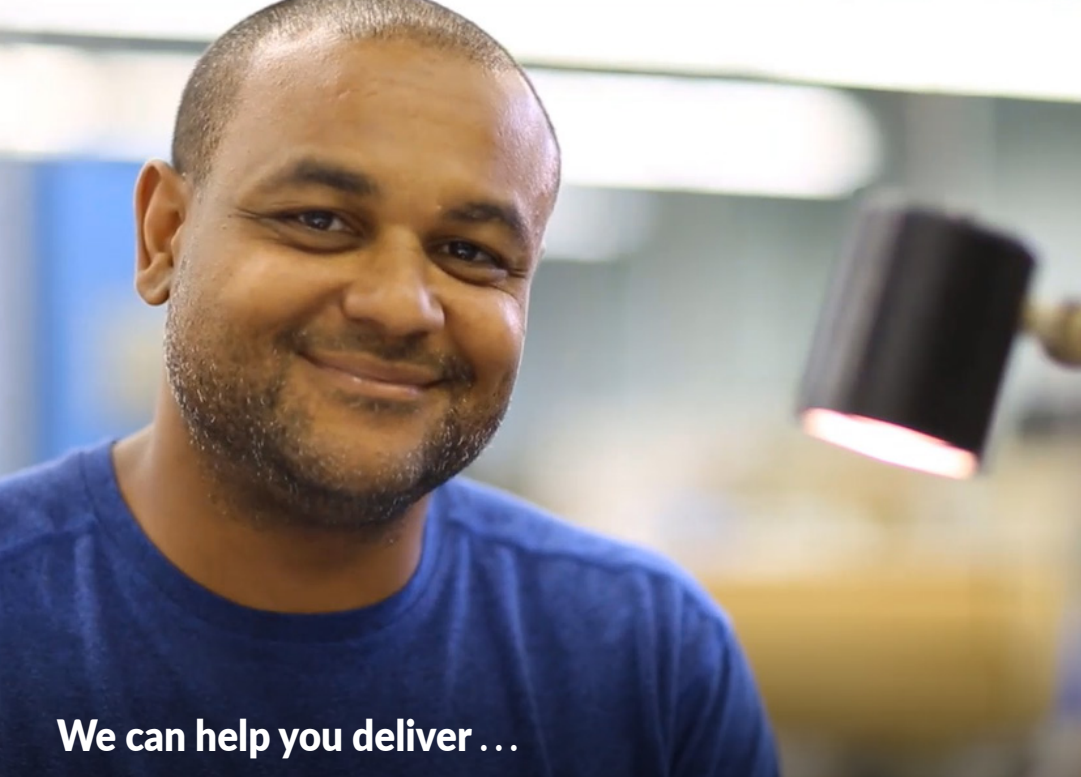

**We can help you deliver ...**

**... the right message  
... to the right people  
... at the right time!**



### VALCOM OFFERS

- Pre-sale design assistance
- Large system site surveys at no cost
- Easy product availability
- Emergency 24/7 technical support at 1.800.VALCOM.1
- Visit [www.valcom.com](http://www.valcom.com) for more information



5614 Hollins Road  
Roanoke, VA 24019

1.540.563.2000  
1.800.VALCOM.1  
[www.valcom.com](http://www.valcom.com)

LIT342-1



Scan for digital copy

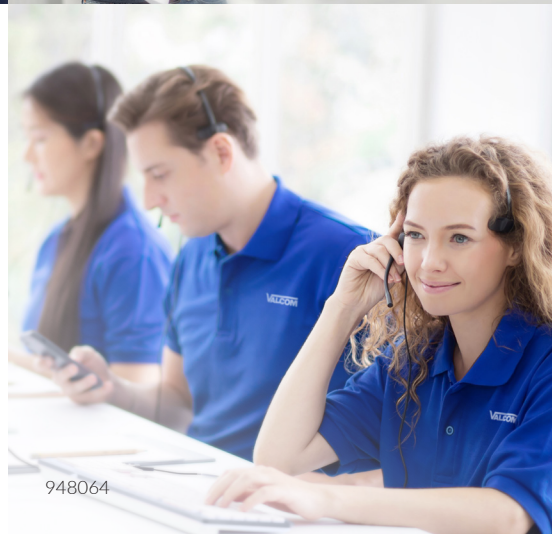

948064