

VL520BK-F-IC / VL520M-F-IC InformaCast® Compliant IP COMPACT SPEAKER WITH TEXT

INTRODUCTION

The VL520-IC InformaCast Compliant IP Large Display Speaker with Text provides highly visible message output and audio paging over an Ethernet network. Audio and Text messages are created and delivered from an InformaCast server.

For InformaCast servers that support SIP (Session Initiation Protocol) endpoint registrations, the VL520-IC can get its SIP information directly from the InformaCast server. Talkback/intercom communications can then be performed through the InformaCast server.

SPECIFICATIONS

Features

- SIP registration to InformaCast Server
- Easy to read, high visibility
- Font and color options
- Power over Ethernet:
(PoE) 802.3af or
(PoE+) 802.3at compatible
- Speaker output and LED display can be activated together or separately
- Display can operate as a clock or provide other message during idle periods
- Contact Closure connection for optional Call switch
- Relay connection for optional equipment
- Bright LED flashers that can be activated based on priority page

Dimensions / Weight

- 20.38" W x 5.5" H x 2.5" D
(51.8cm W x 14.0cm H x 6.4cm D)
- Weight:

VL520BK-F-IC	4.65 lb (2.1kg)
VL520M-F-IC (Metallic)	5.95 lb (2.7kg)

Nominal Power Requirements

- 802.3af (PoE) Class 3
or
- 802.3at (PoE+) Class 4

Environment

Temperature: 0 to +40° C
Humidity: 0 to 85% non-precipitating



Black (BK)



Metallic (M)

These products are intended for use with a UL Listed power source marked "Class 2" or "LPS" rated 24VDC, or 48VDC (PoE). PoE and all interconnected ITE are intended for intra-building.

Precautionary Designations

- **WARNING: To Reduce The Risk Of Fire Or Electric Shock. Do Not Expose This Apparatus To Rain Or Moisture.**
- **AVERTISSEMENT: Afin de réduire les risques d'incendie ou de décharge électrique, évitez d'exposer le système à la pluie ou à l'humidité.**
- **Apparatus shall not be exposed to dripping or splashing and no objects filled with liquids, such as vases, shall be placed on the apparatus.**
- **L'appareil ne doit pas être exposé à des égouttements et éclaboussures et aucun Objet Rempli de liquide, comme vase, ne doit être placé sur l'appareil.**



IMPORTANT SAFETY INFORMATION



CONSIGNES DE SÉCURITÉ IMPORTANTES

1. Read these instructions.
Lisez ces instructions.
2. Keep these instructions.
Conservez ces instructions.
3. Heed all warnings.
Respectez tous les avertissements.
4. Follow all instructions.
Suivez toutes les instructions.
5. Do not use this apparatus near water.
Ne pas utiliser cet appareil près de l'eau.
6. Clean only with dry cloth.
Nettoyer avec un chiffon sec.
7. Do not block any ventilation openings. Install in accordance with the manufacturer's instructions.
Ne pas bloquer les ouvertures de ventilation. Installer conformément aux instructions du fabricant.
8. Do not install near any heat sources such as radiators, heat registers, stoves or other apparatus (including amplifiers) that produce heat.
Ne pas installer à proximité de sources de chaleur telles que radiateurs, registres de chaleur, poêles ou autres appareils (y compris les amplificateurs) produisant de la chaleur.
9. Do not defeat the safety purpose of the polarized or grounding-type plug. A polarized plug has two blades with one wider than the other. A grounding type plug has two blades and a third grounding prong. The wide blade and the third prong are provided for your safety. If the provided plug does not fit into your outlet consult an electrician for replacement of the obsolete outlet.
Ne pas contourner le dispositif de sécurité de la fiche polarisée ou de mise à la terre. Une fiche polarisée possède deux lames dont une plus large que l'autre. Une fiche de terre a deux lames et une troisième broche de mise à la terre. La lame large et la troisième broche sont fournies pour votre sécurité. Si la fiche fournie ne rentre pas dans votre prise, veuillez consulter un électricien pour le remplacement de la prise obsolète.
10. Protect the power cord from being walked on or pinched particularly at plugs, convenience receptacles and the point where they exit from the apparatus.
11. Only use attachments/accessories specified by the manufacturer.
N'utilisez que des fixations / accessoires spécifiés par le fabricant.
12. Use only with the cart, stand, tripod, bracket or table specified by the manufacturer or sold with the apparatus. When a cart is used, use caution when moving the cart/apparatus combination to avoid injury from tip-over.

Utilisez uniquement avec le chariot, stand, trépied, support ou table spécifié par le fabricant ou vendu avec l'appareil. Quand un chariot est utilisé, Soyez prudent lorsque vous déplacez l'ensemble chariot / appareil pour éviter des blessures dues au renversement.
13. Unplug this apparatus during lightning storms or when unused for a long period of time.
Débranchez cet appareil pendant les orages ou lorsqu'il n'est pas utilisé pendant une longue période de temps.
14. Refer all servicing to qualified service personnel. Servicing is required when the apparatus has been damaged in any way. Such as when the power supply cord or plug is damaged, liquid has been spilled, objects have fallen into the apparatus or the apparatus has been exposed to rain or moisture and does not operate normally or has been dropped.
Confiez toute réparation à un personnel qualifié. Une réparation est nécessaire lorsque l'appareil a été endommagé de quelque façon. Par exemple lorsque le cordon d'alimentation ou la fiche est endommagé, du liquide a été renversé, si des objets sont tombés dans l'appareil ou le appareil a été exposé à la pluie ou à l'humidité et ne fonctionne pas normalement ou s'il est tombé.

FCC Information

This equipment has been tested and found to comply with the limits for a Class A digital device, pursuant to Part 15 of the FCC Rules. These limits are designed to provide reasonable protection against harmful interference when the equipment is operated in a commercial environment. This equipment generates, uses and can radiate radio frequency energy and if not installed and used in accordance with the instruction manual, may cause harmful interference to radio communications. Operation of this equipment in a residential area may cause harmful interference in which case the user will be required to correct the interference at one's own expense.

	CAUTION RISK OF ELECTRIC SHOCK DO NOT OPEN	
CAUTION: To reduce the risk of electric shock, Do not remove cover (or back). No user serviceable parts inside. Refer servicing to qualified service personnel.		

	This symbol indicates that dangerous voltage constituting a risk of electric shock is present within this unit.
	This symbol indicates that there are important operating and maintenance instructions in the literature accompanying this unit.

INSTALLATION

Mounting

The VL520-IC message display should be mounted with appropriate hardware (not included). We recommend the mounting base to be mounted into wall studs. (See Figure 2).

CONNECTIONS

Network Connection / Power

The VL520-IC has one RJ-45 network connector. Connect a standard patch cable to the VL520-IC from an Ethernet switch supporting the Power over Ethernet specification 802.3af (PoE) or 802.3at (PoE+). If a PoE switch is not available, a mid-span injector may be used to supply power to the display, or an optional Valcom 24Vdc power adapter may be connected to the barrel connector on the circuit board (see Figure 1).

The recommended power supply is a VP-1124D.

Call Switch Connection

NOTE: Switch 2 Input is not used at this time. The VL520-IC provides a call switch input via screw terminal connections labeled Switch 1. (See Figure 1)

Relay Connection

One relay output is provided through three screw terminals labeled Normally Open (NO) and Normally Closed (NC). The center screw terminal is common to both NO and NC. The relay contacts are rated 1 amp @ 24Vdc.

Line Out Connection

The Line Out connection provides line level output sufficient to drive up to 40 Valcom self-amplified speakers.

Status / Demo / Reset

A multifunction button is provided to display information, and/or reset the VL520-IC configuration. The button is located behind a pinhole in the case of the VL520-IC and can be depressed using a small diameter object, such as a toothpick. The button provides different results depending on how long the button remains depressed.

Status Mode

Press the button for approximately 1 second and release and the Status display will show the current IP Address, Power Source status and the last four digits of the MAC address.

Demo Mode

While the Status display is active, pressing the button again will enable Demo Mode. In this mode, the VL520-IC will display a scrolling sample message and the flashers will flash. Demo Mode will display for about 30 seconds then the VL520-IC returns to normal operation.

Reset Modes

Pressing the button continuously for greater than 10 seconds, but less than 20 seconds, will perform a soft reset on the VL520-IC. The IP address will be reset to the factory default setting. Other configuration items will not be affected.

Pressing the button continuously for greater than 20 seconds will perform a hard reset on the VL520-IC. All of the configuration items (including the password) will be reset to factory default settings.

Setup

The VL520-IC will automatically acquire an IP address (using DHCP) and connect to the InformaCast server when connected to the network and powered up. Information specific to your application will need to be programmed into the InformaCast server. Refer to the InformaCast documentation for further information.

TECHNICAL ASSISTANCE

Assistance is available from the factory when problems are encountered. Call (540) 563-2000 and press 1 for Technical Support or visit our website at <http://www.valcom.com>

Valcom, Inc. equipment is not field repairable. Valcom maintains service facilities in Roanoke, VA.

Should repairs be necessary, attach a tag to the unit clearly stating company name, address, phone number, contact person, and the nature of the problem.

Send the unit to:

**Valcom, Inc.
Repair and Return Dept.
5614 Hollins Road
Roanoke, VA 24019-5056**

WARRANTY

Warranty information may be found on our website at www.valcom.com/warranty.

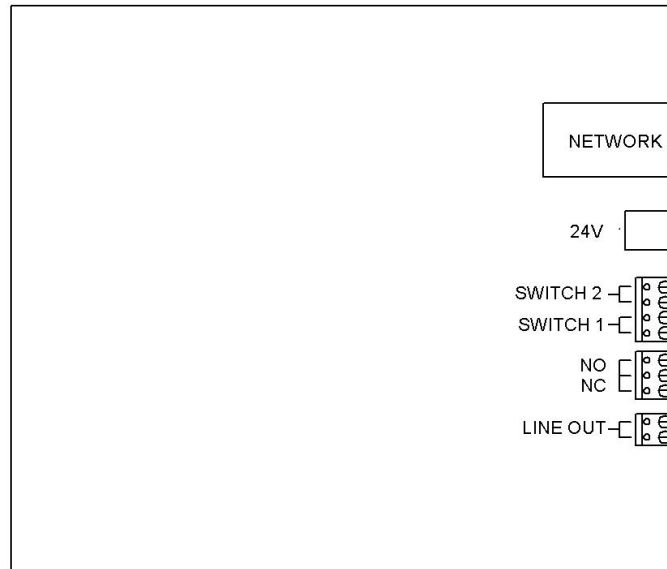

Figure 1. Network Connections

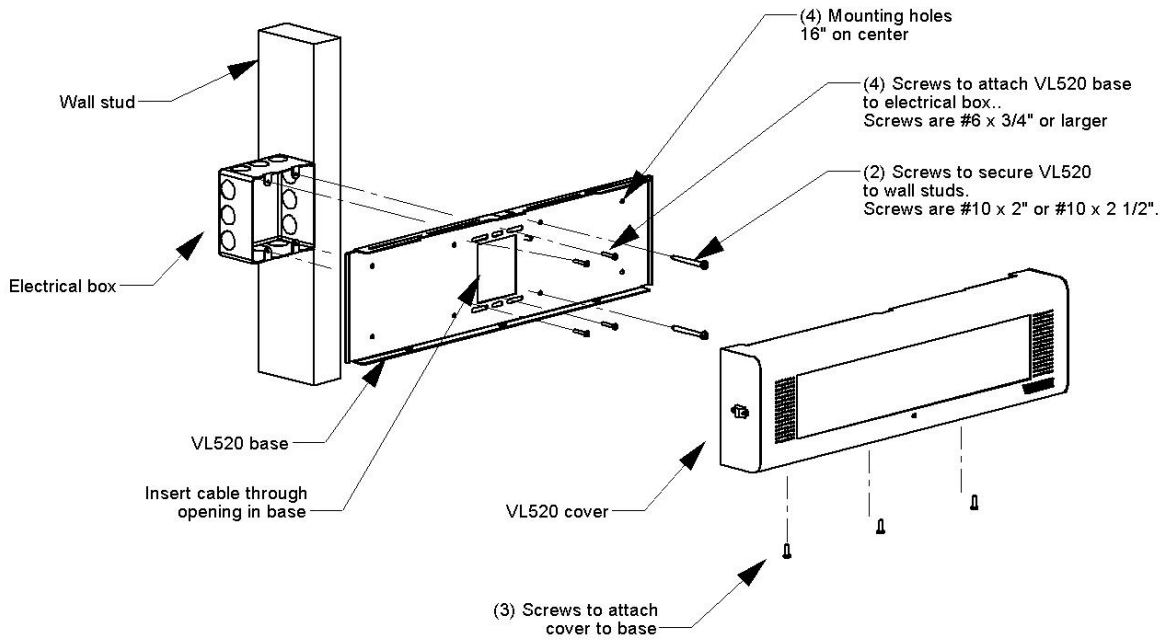

Figure 2. Mounting Diagram