

IP PoE Double Sided Analog Clocks VIP-A12DS, 12" Round VIP-A16DS, 16" Round



INTRODUCTION

The VIP-A12DS 12 inch Round Analog and VIP-A16DS 16 inch Round Analog Clocks enable time indication, synchronization, and correction over an IP-based LAN/WAN. This allows locating a clock display anywhere on the network. Clock synchronization is initiated via connection to a factory preprogrammed time server or can be programmed to sync with any NTP (Network Time Protocol) server. The enclosure is made of steel with a durable powder coated finish. The color of the enclosure can easily be changed to match any décor. Power is provided to the VIP-A12DS and VIP-A16DS via a Power over Ethernet (PoE) switch meeting the 802.3af specification. Only one network connection is required, supplying power and data to both clock displays.

SPECIFICATIONS

Features

- High visibility white face
- Shatterproof, polycarbonate crystal
- 802.3af Power over Ethernet (PoE) compatible
- High Efficiency

INSTALLATION

FCC Information

This equipment has been tested and found to comply with the limits for a Class A digital device, pursuant to Part 15 of the FCC Rules. These limits are designed to provide reasonable protection against harmful interference when the equipment is operated in a commercial environment. This equipment generates, uses and can radiate radio frequency energy and if not installed and used in accordance with the instruction manual, may cause harmful interference to radio communications. Operation of this equipment in a residential area may cause harmful interference in which case the user will be required to correct the interference at one's own expense.

DIMENSIONS/WEIGHT

- VIP-A12DS – 12.81" diameter x 7.00" depth
17.6" maximum extension from wall or ceiling
Weight: 11.00 lbs
- VIP-A16DS – 16.81" diameter x 7.25" depth
21.6" maximum extension from wall or ceiling
Weight: 12.6 lbs

Nominal Power Requirements

802.3af PoE:

Class 3

Environment





Temperature:

0 to +45° C

Humidity:

0 to 85% non-precipitating

Precautionary Designations

	CAUTION RISK OF ELECTRIC SHOCK DO NOT OPEN	
<p>CAUTION: To reduce the risk of electric shock, Do not remove cover. No user serviceable parts inside. Refer servicing to qualified service personnel.</p>		
	<p>This symbol indicates that dangerous voltage constituting a risk of electric shock is present within this unit.</p>	
	<p>This symbol indicates that there are important operating and maintenance instructions in the literature accompanying this unit.</p>	

Packing List

Qty.	Item
2	12" or 16" Clocks
1	Network Interface
1	Double Sided Housing
1	VSP Document

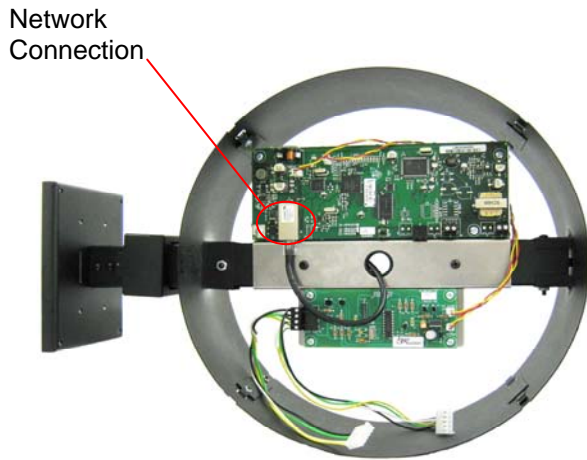

VIP-A12DS Housing Assembly

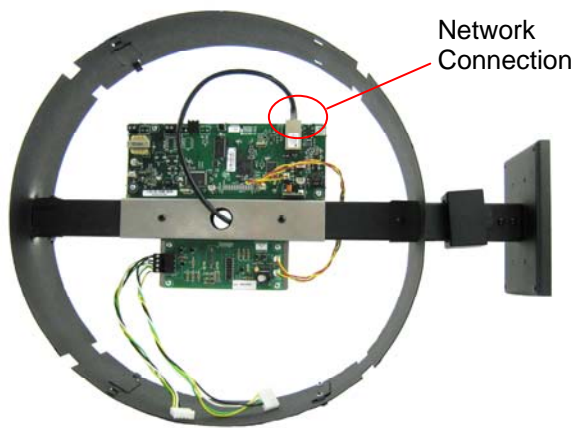

VIP-A16DS Housing Assembly

MOUNTING/CONNECTIONS

A minimum of 18" (for the VIP-A12DS) or 24" (for the VIP-A16DS) of network cable must extend from the mounting location for connection to the RJ45 jack on the Network Interface inside the clock housing.

A safety restraint cable (not included) is strongly recommended to be installed in addition to the mounting bracket attachment to the wall or ceiling. Insert the cable through the back of the mounting bracket, through the center support bracket, and out the large center hole. Securely attach the end of the safety restraint cable to one of the predrilled holes in the center support bracket. The other end of the safety restraint cable should be securely attached to the building structure.

Remove the shipping screws holding the mounting bracket to the clock housing. Insert the network cable through the back of the mounting bracket, then attach the bracket to a double gang outlet box using the four inner holes on the mounting bracket. Use the four outer mounting holes if attaching directly to a wall or ceiling.

Align the clock housing over the mounting bracket flange and secure the clock housing to the flange with eight screws provided (four each side). Confirm the two screws at the opposite end of the center support bracket are firmly tightened.

The Network Interface unit attaches to the center support bracket inside the housing. Align the center cable hole and two screw holes in the Network Interface mounting plate with the predrilled holes in the hanging rod and attach using two screws (included).

Feed the network cable from the mounting bracket into the clock housing. Be careful to not damage the RJ45 connector on the cable.

Connect the network cable to the RJ45 jack on the Network Interface in the housing.

Attach one 5-pin female molex connector from the Network Interface to the clock movement on the back of the clock, then slide the clock onto the housing and secure by tightening two screws on the housing. Repeat this procedure for the other clock face.

Setup

Information specific to your application will need to be programmed into the VIP-A1xDS using a computer. The PC used for programming should be connected to the same subnet as the VIP-A1xDS. Setup will be done using the IP Solutions Setup Tool. Download the latest version of the free IP Solutions Setup Tool from the Valcom.com web site at www.valcom.com/vipsetuptool.

TECHNICAL ASSISTANCE

When trouble is reported, verify power is being supplied to the unit and there are no broken connections. If a spare unit is available, substitute a spare unit for the suspected defective unit.

Assistance in troubleshooting is available from the factory. Call (540) 563-2000 and press 1 for Technical Support or via email at support@valcom.com

When requesting assistance, you should include all available information. It is strongly suggested that you go to the web site and review the documentation at: <http://www.valcom.com>.

Valcom equipment is not field-repairable. Valcom, Inc. maintains service facilities in Roanoke, VA. Should repairs be necessary, attach a tag to the unit clearly stating your company name, address, phone number, contact person and the nature of the problem. Send the unit to:

Valcom, Inc.
Repair & Return Dept.
5614 Hollins Road
Roanoke, Va. 24019-5056

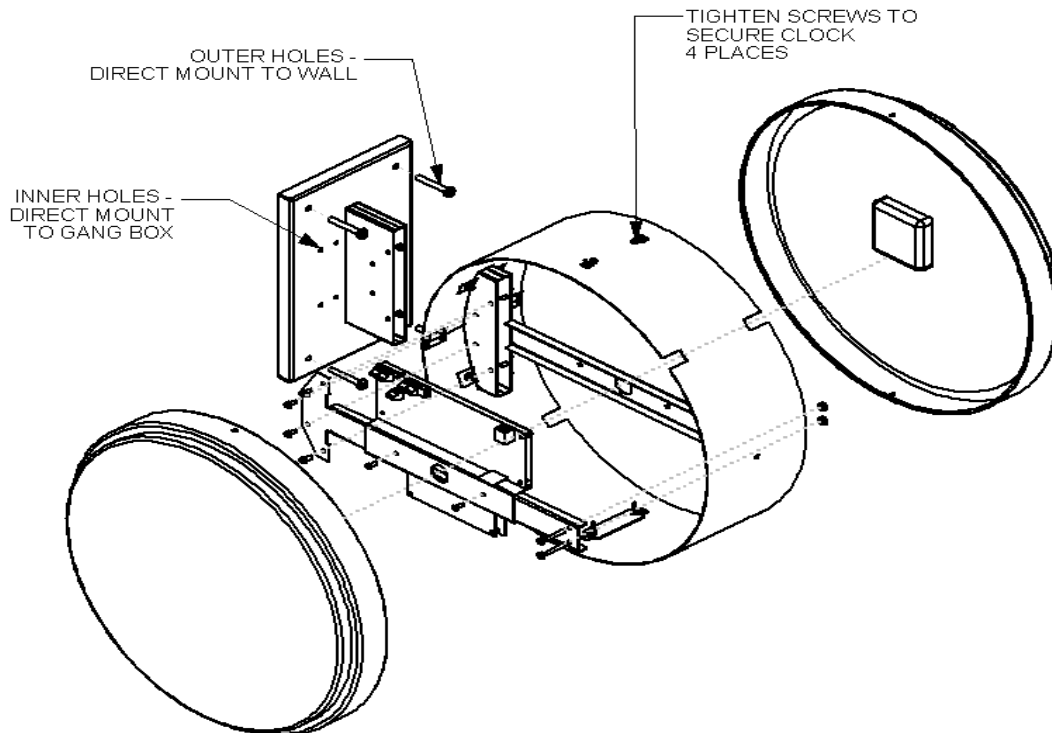

Figure 1. Assembly Diagram

VALCOM LIMITED WARRANTY

Valcom, Inc. warrants its products only to the original purchaser, for its own use, to be free from defects in materials and workmanship under conditions of normal use and service for a period of one year from the date of shipment. This Limited Warranty obligation shall be limited to the replacement, repair or refund of any such defective device within the warranty period, provided that:

1. inspection by Valcom, Inc. indicates the validity of the claim;
2. the defect is not the result of damage, misuse or negligence after the original shipment;
3. the product has not been altered in any way or repaired by others and that factory sealed units are unopened (a service charge plus parts and labor will be applied to units defaced or physically damaged);
4. freight charges for the return of products to Valcom are prepaid;
5. all units 'out of warranty' are subject to a service charge. The service charge will cover minor repairs (major repairs will be subject to additional charges for parts and labor).

This Limited Warranty is in lieu of and excludes all other warranties, expressed or implied and in no event shall Valcom, Inc. be liable for any anticipated profits, consequential damages, loss of time or other losses incurred by the buyer in connection with the purchase, operation, maintenance, installation, removal or use of the product. The maximum liability of Valcom under this warranty is limited to the purchase price of the specific Product covered by the warranty.

Disclaimer. Except for the Limited Warranty provided herein, the product is provided "as-is" without any warranty of any kind whatsoever including, without limitation, any **WARRANTY OF MERCHANTABILITY, FITNESS FOR A PARTICULAR PURPOSE OR NON-INFRINGEMENT.**

This warranty specifically excludes damage incurred in shipment. In the event a product is received in damaged condition, the carrier should be notified immediately. Claims for such damage should be filed with the carrier involved in accordance with the F.O.B. point.

Headquarters:

Valcom, Inc.

5614 Hollins Road Roanoke, VA 24019-5056

Phone: (540) 563-2000 FAX: (540) 362-9800